

### General Description

The MDD7N20C uses advanced Magnachip's MOSFET Technology, which provides low on-state resistance, high switching performance and excellent quality.

MDD7N20C is suitable device for SMPS, HID and general purpose applications.

### Features

- $V_{DS} = 200V$
- $I_D = 5.0A$
- $R_{DS(ON)} \leq 0.69\Omega$  @  $V_{GS} = 10V$

### Applications

- Power Supply
- PFC
- LED TV

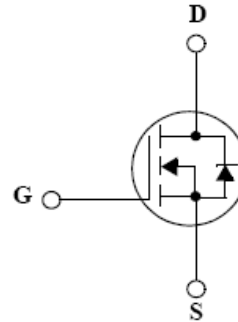
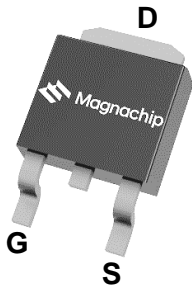

### Absolute Maximum Ratings (Ta = 25°C)

Characteristics	Symbol	Rating	Unit
Drain-Source Voltage	$V_{DSS}$	200	V
Gate-Source Voltage	$V_{GSS}$	±30	V
Continuous Drain Current	$I_D$	$T_C=25^\circ C$	5.0
		$T_C=100^\circ C$	3.1
Pulsed Drain Current <sup>(1)</sup>	$I_{DM}$	20	A
Power Dissipation	$P_D$	$T_C=25^\circ C$	38.4
		Derate above 25 °C	0.31
Peak Diode Recovery $dv/dt$ <sup>(3)</sup>	$dv/dt$	4.5	V/ns
Repetitive Pulse Avalanche Energy <sup>(1)</sup>	$E_{AR}$	3.84	mJ
Avalanche current <sup>(1)</sup>	$I_{AR}$	5.0	A
Single Pulse Avalanche Energy <sup>(4)</sup>	$E_{AS}$	62.5	mJ
Junction and Storage Temperature Range	$T_J, T_{stg}$	-55~150	°C

### Thermal Characteristics

Characteristics	Symbol	Rating	Unit
Thermal Resistance, Junction-to-Ambient <sup>(1)</sup>	$R_{\theta JA}$	110	°C/W
Thermal Resistance, Junction-to-Case <sup>(1)</sup>	$R_{\theta JC}$	3.25	

## Ordering Information

Part Number	Marking	Temp. Range	Package	Packing	RoHS Status
MDD7N20CRH	MDD7N20C	-55~150°C	TO-252 (DPAK)	Reel and Tape	Halogen Free

## Electrical Characteristics (Ta =25°C)

Characteristics	Symbol	Test Condition	Min	Typ	Max	Unit
<b>Static Characteristics</b>						
Drain-Source Breakdown Voltage	$BV_{DSS}$	$I_D = 250\mu A, V_{GS} = 0V$	200	-	-	V
Gate Threshold Voltage	$V_{GS(th)}$	$V_{DS} = V_{GS}, I_D = 250\mu A$	2.0	-	4.0	
Drain Cut-Off Current	$I_{DSS}$	$V_{DS} = 200V, V_{GS} = 0V$	-	-	1	$\mu A$
Gate Leakage Current	$I_{GSS}$	$V_{GS} = \pm 30V, V_{DS} = 0V$	-	-	100	nA
Drain-Source ON Resistance	$R_{DS(ON)}$	$V_{GS} = 10V, I_D = 2.5A$	-	0.58	0.69	$\Omega$
Forward Transconductance	$g_{fs}$	$V_{DS} = 30V, I_D = 2.5A$	-	2.7	-	S
<b>Dynamic Characteristics</b>						
Total Gate Charge	$Q_g$	$V_{DS} = 200V, I_D = 7A, V_{GS} = 10V$	-	5.1	-	nC
Gate-Source Charge	$Q_{gs}$		-	1.5	-	
Gate-Drain Charge	$Q_{gd}$		-	2.0	-	
Input Capacitance	$C_{iss}$	$V_{DS} = 25V, V_{GS} = 0V, f = 1.0MHz$	-	182	-	pF
Reverse Transfer Capacitance	$C_{rss}$		-	5.6	-	
Output Capacitance	$C_{oss}$		-	46.9	-	
Turn-On Delay Time	$t_{d(on)}$	$V_{GS} = 10V, V_{DS} = 100V, I_D = 7A, R_G = 25\Omega$	-	6.3	-	ns
Rise Time	$t_r$		-	23	-	
Turn-Off Delay Time	$t_{d(off)}$		-	10.7	-	
Fall Time	$t_f$		-	19.5	-	
<b>Drain-Source Body Diode Characteristics</b>						
Maximum Continuous Drain to Source Diode Forward Current	$I_S$		-	5.0	-	A
Source-Drain Diode Forward Voltage	$V_{SD}$	$I_S = 7.0A, V_{GS} = 0V$	-	-	1.4	V
Body Diode Reverse Recovery Time	$t_{rr}$	$I_F = 7.0A, di/dt = 100A/\mu s$	-	88	-	ns
Body Diode Reverse Recovery Charge	$Q_{rr}$		-	0.25	-	$\mu C$

Note :

1. Pulse width is based on  $R_{\theta JC}$  &  $R_{\theta JA}$  and the maximum allowed junction temperature of 150°C.
2. Pulse test: pulse width  $\leq 300\mu s$ , duty cycle  $\leq 2\%$ , pulse width limited by junction temperature  $T_{J(MAX)} = 150^\circ C$ .
3.  $I_{SD} \leq 5A$ ,  $di/dt \leq 300A/\mu s$ ,  $V_{DD} \leq BV_{DSS}$ , Starting  $T_J = 25^\circ C$
4.  $L = 3.75mH$ ,  $I_{AS} = 5.0A$ ,  $V_{DD} = 50V$ ,  $R_G = 25\Omega$ , Starting  $T_J = 25^\circ C$

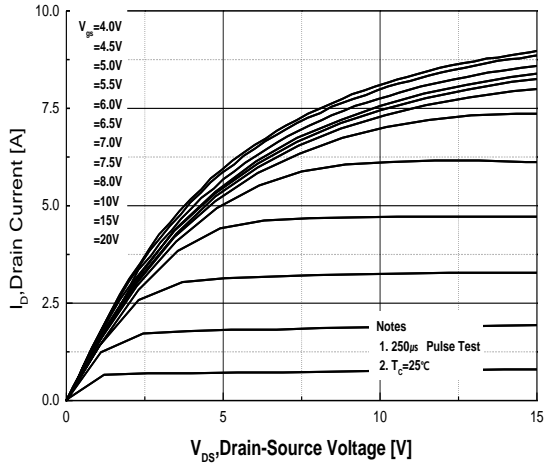

**Fig.1 On-Region Characteristics**

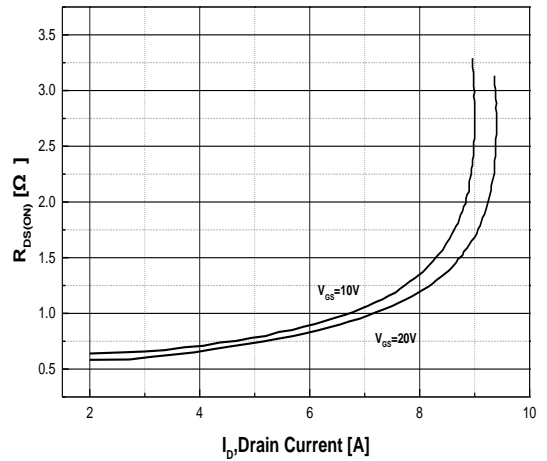

**Fig.2 On-Resistance Variation with Drain Current and Gate Voltage**

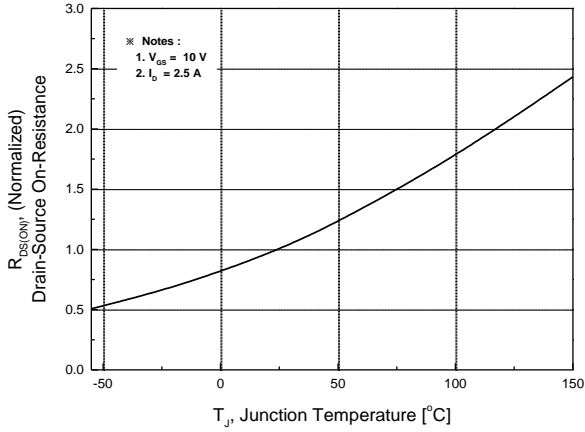

**Fig.3 On-Resistance Variation with Temperature**

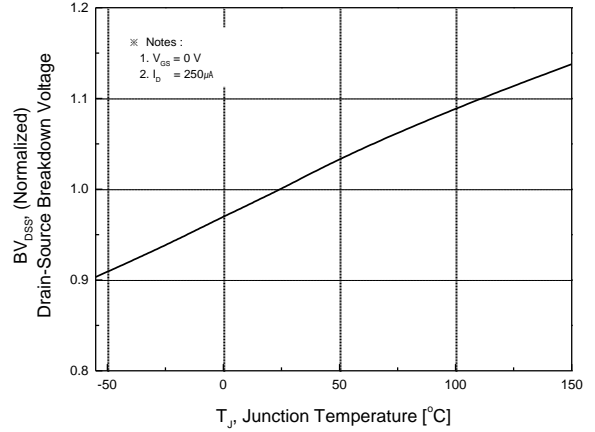

**Fig.4 Breakdown Voltage Variation vs. Temperature**

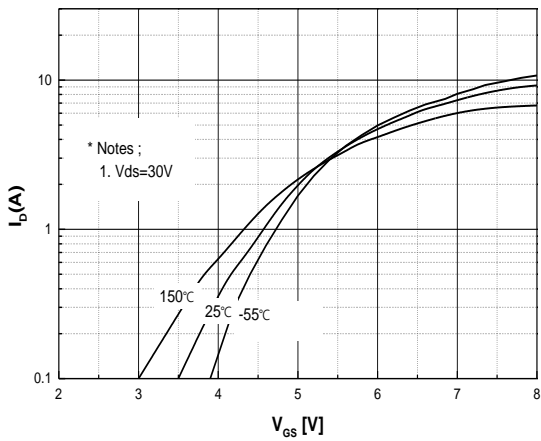

**Fig.5 Transfer Characteristics**

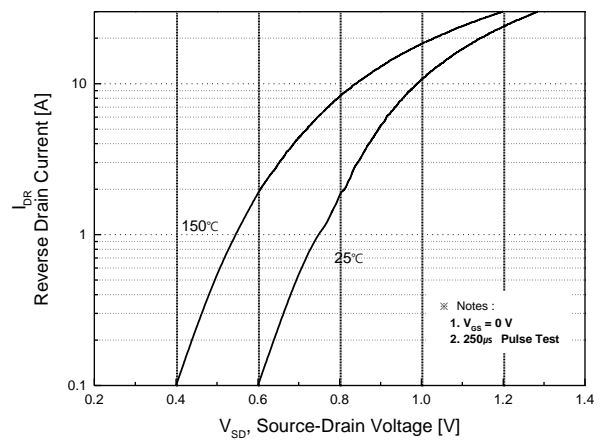

**Fig.6 Body Diode Forward Voltage Variation with Source Current and Temperature**

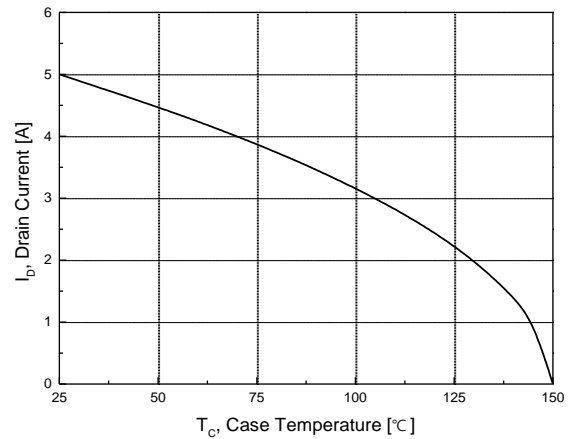
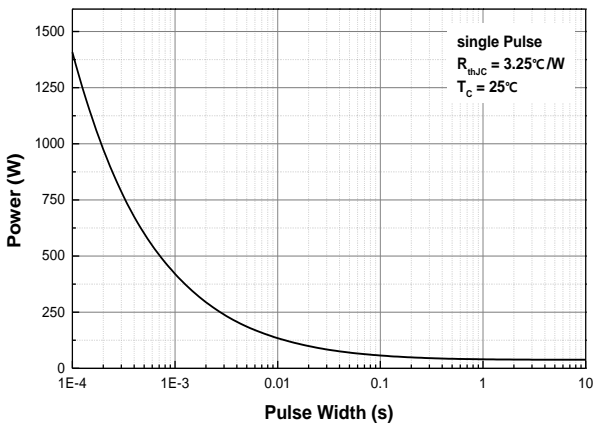
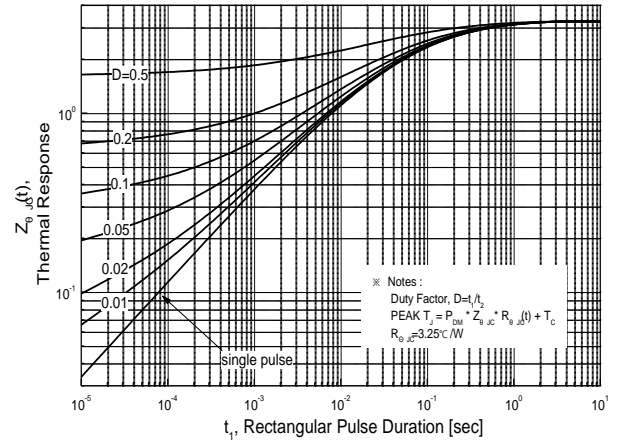
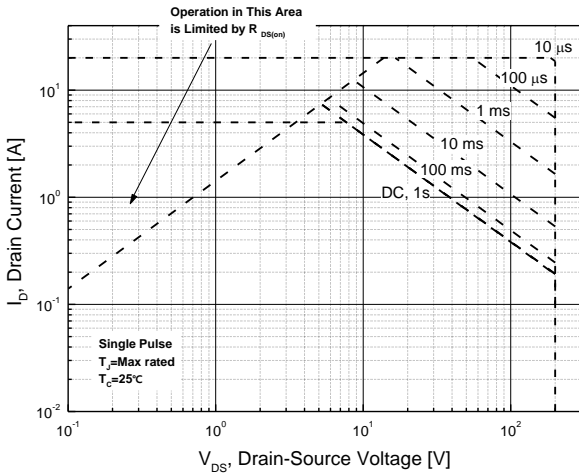
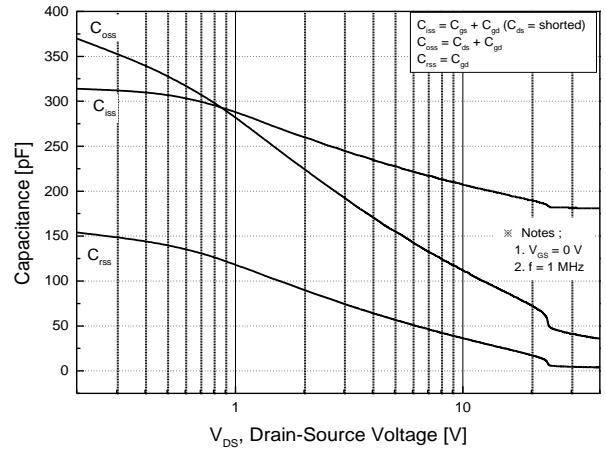
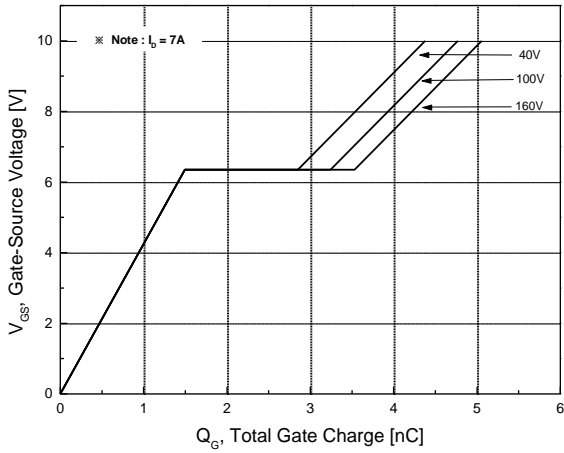

**Physical Dimension**

**TO-252 (DPAK)**

Dimensions are in millimeters, unless otherwise specified

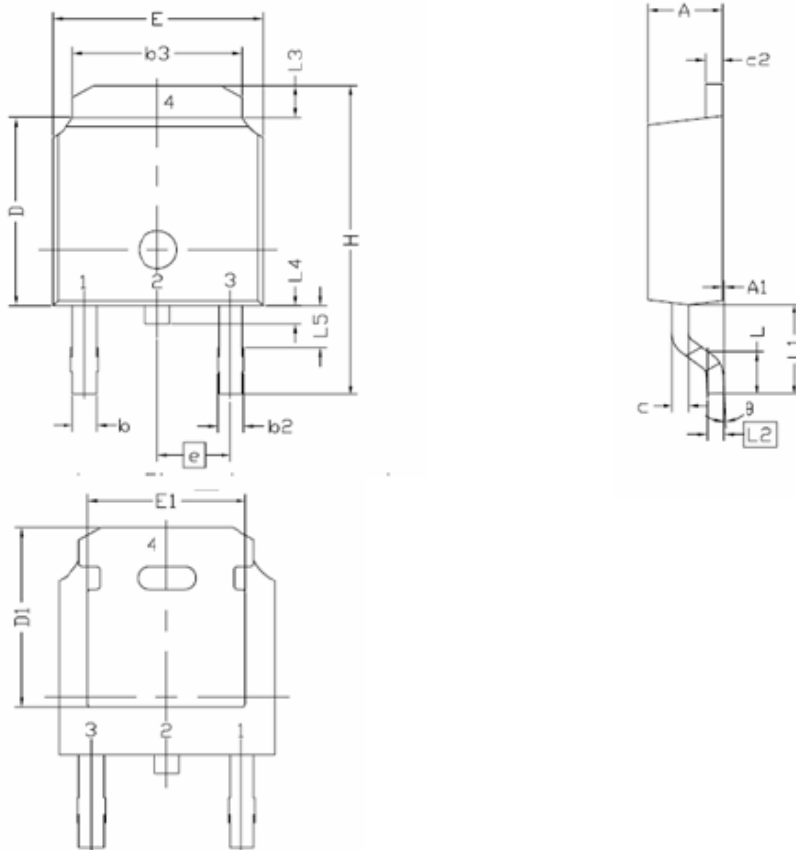

Symbol	Min	Nom	Max
E	6.35	-	6.73
L	1.40	1.52	1.78
L1	2.74REF		
L2	0.508BCS		
L3	0.89	-	1.27
L4	-	-	1.02
L5	1.14	-	1.52
D	5.97	6.10	6.22
H	9.40	-	10.41
b	0.64	-	0.89
b2	0.76	-	1.14
b3	4.95	-	5.46
e	2.286BSC		
A	2.18	-	2.39
A1	-	-	0.13
c	0.46	-	0.61
c2	0.46	-	0.89
D1	5.21	-	-
E1	4.32	-	-
Θ	0.00	-	10.00

**DISCLAIMER:**

The Products are not designed for use in hostile environments, including, without limitation, aircraft, nuclear power generation, medical appliances, and devices or systems in which malfunction of any Product can reasonably be expected to result in a personal injury. Seller's customers using or selling Seller's products for use in such applications do so at their own risk and agree to fully defend and indemnify Seller.

Magnachip reserves the right to change the specifications and circuitry without notice at any time. Magnachip does not consider responsibility for use of any circuitry other than circuitry entirely included in a Magnachip product.  Magnachip is a registered trademark of Magnachip Semiconductor Ltd.