

### General Description

These N-channel MOSFET are produced using advanced Magnachip's MOSFET Technology, which provides low on-state resistance, high switching performance and excellent quality.

These devices are suitable device for SMPS, high Speed switching and general purpose applications.

### Features

- $V_{DS} = 500V$
- $V_{DS} = 550V$  @  $T_{jmax}$
- $I_D = 13.0A$  @  $V_{GS} = 10V$
- $R_{DS(ON)} < 0.5\Omega$  @  $V_{GS} = 10V$

### Applications

- Power Supply
- HID
- Lighting



TO-220FT

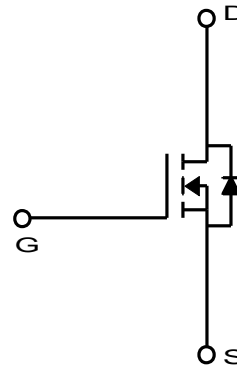

### Absolute Maximum Ratings (Ta = 25°C)

Characteristics		Symbol	Rating	Unit
Drain-Source Voltage		$V_{DSS}$	500	V
Drain-Source Voltage @ $T_{jmax}$		$V_{DSS} @ T_{jmax}$	550	V
Gate-Source Voltage		$V_{GSS}$	±30	V
Continuous Drain Current	$T_C=25^\circ C$	$I_D$	13*	A
	$T_C=100^\circ C$		8.2*	A
Pulsed Drain Current <sup>(1)</sup>		$I_{DM}$	52*	A
Power Dissipation	$T_C=25^\circ C$	$P_D$	42	W
	Derate above 25 °C		0.33	W/°C
Repetitive Avalanche Energy <sup>(1)</sup>		$E_{AR}$	18.7	mJ
Peak Diode Recovery $dv/dt$ <sup>(3)</sup>		$dv/dt$	4.5	V/ns
Single Pulse Avalanche Energy <sup>(4)</sup>		$E_{AS}$	580	mJ
Junction and Storage Temperature Range		$T_J, T_{stg}$	-55~150	°C

\*  $I_D$  limited by maximum junction temperature

### Thermal Characteristics

Characteristics	Symbol	Rating	Unit
Thermal Resistance, Junction-to-Ambient <sup>(1)</sup>	$R_{\theta JA}$	62.5	°C/W
Thermal Resistance, Junction-to-Case <sup>(1)</sup>	$R_{\theta JC}$	3.0	

## Ordering Information

Part Number	Marking	Temp. Range	Package	Packing	RoHS Status
MDFS13N50GTH-T	MDFS13N50G	-55~150°C	TO-220F(Thin lead frame)	Tube	Halogen Free

## Electrical Characteristics (Ta =25°C)

Characteristics	Symbol	Test Condition	Min	Typ	Max	Unit
<b>Static Characteristics</b>						
Drain-Source Breakdown Voltage	$BV_{DSS}$	$I_D = 250\mu A, V_{GS} = 0V$	500	-	-	V
Gate Threshold Voltage	$V_{GS(th)}$	$V_{DS} = V_{GS}, I_D = 250\mu A$	3.0	-	5.0	
Drain Cut-Off Current	$I_{DSS}$	$V_{DS} = 500V, V_{GS} = 0V$	-	-	1	$\mu A$
Gate Leakage Current	$I_{GSS}$	$V_{GS} = \pm 30V, V_{DS} = 0V$	-	-	100	nA
Drain-Source ON Resistance	$R_{DS(ON)}$	$V_{GS} = 10V, I_D = 6.5A$		0.39	0.5	$\Omega$
Forward Transconductance	$g_{fs}$	$V_{DS} = 40V, I_D = 6.5A$	-	13	-	S
<b>Dynamic Characteristics</b>						
Total Gate Charge	$Q_g$	$V_{DS} = 400V, I_D = 13A, V_{GS} = 10V^{(3)}$	-	33		nC
Gate-Source Charge	$Q_{gs}$		-	10.4		
Gate-Drain Charge	$Q_{gd}$		-	13		
Input Capacitance	$C_{iss}$	$V_{DS} = 25V, V_{GS} = 0V, f = 1.0MHz$	-	1390		pF
Reverse Transfer Capacitance	$C_{rss}$		-	6.3		
Output Capacitance	$C_{oss}$		-	173		
Turn-On Delay Time	$t_{d(on)}$	$V_{GS} = 10V, V_{DS} = 250V, I_D = 13A, R_G = 25\Omega^{(3)}$	-	57		ns
Rise Time	$t_r$		-	54		
Turn-Off Delay Time	$t_{d(off)}$		-	112		
Fall Time	$t_f$		-	37		
<b>Drain-Source Body Diode Characteristics</b>						
Maximum Continuous Drain to Source Diode Forward Current	$I_S$		-	13	-	A
Source-Drain Diode Forward Voltage	$V_{SD}$	$I_S = 13A, V_{GS} = 0V$	-		1.4	V
Body Diode Reverse Recovery Time	$t_{rr}$	$I_F = 13A, di/dt = 100A/\mu s^{(3)}$	-	325		ns
Body Diode Reverse Recovery Charge	$Q_{rr}$		-	2.9		$\mu C$

Note :

1. Pulse width is based on  $R_{\theta JC}$  &  $R_{\theta JA}$  and the maximum allowed junction temperature of 150°C.
2. Pulse test: pulse width  $\leq 300\mu s$ , duty cycle  $\leq 2\%$ , pulse width limited by junction temperature  $T_J(MAX)=150^\circ C$ .
3.  $I_{SD} \leq 9.0A$ ,  $di/dt \leq 200A/\mu s$ ,  $V_{DD}=50V$ ,  $R_G = 25\Omega$ , Starting  $T_J=25^\circ C$
4.  $L=6.2mH$ ,  $I_{AS}=13.0A$ ,  $V_{DD}=50V$ ,  $R_G = 25\Omega$ , Starting  $T_J=25^\circ C$

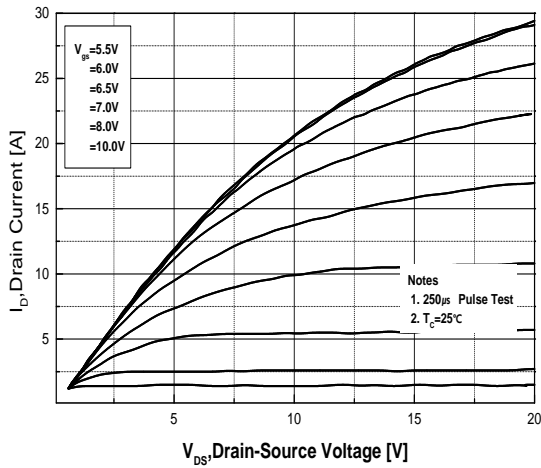

**Fig.1 On-Region Characteristics**

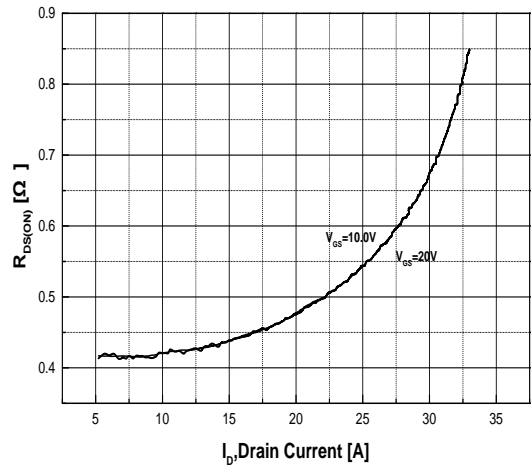

**Fig.2 On-Resistance Variation with Drain Current and Gate Voltage**

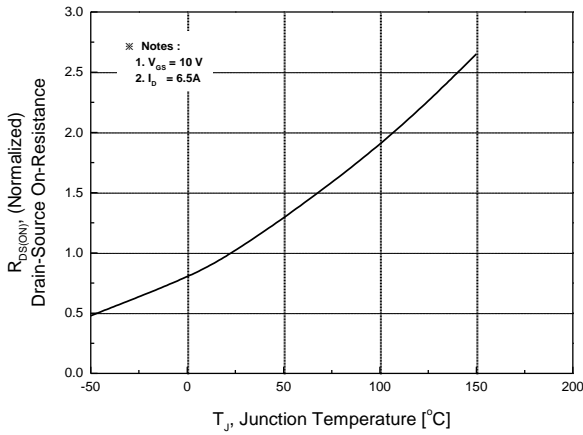

**Fig.3 On-Resistance Variation with Temperature**

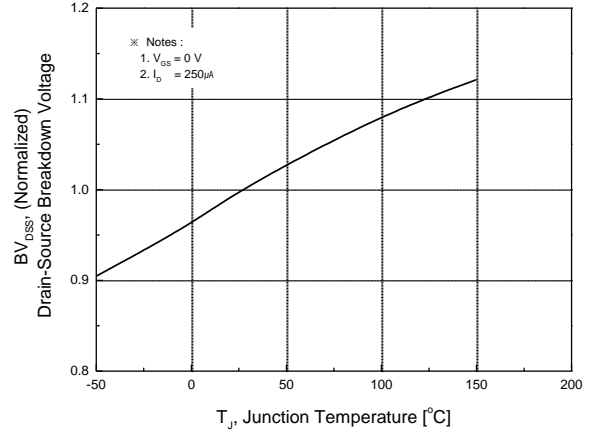

**Fig.4 Breakdown Voltage Variation vs. Temperature**

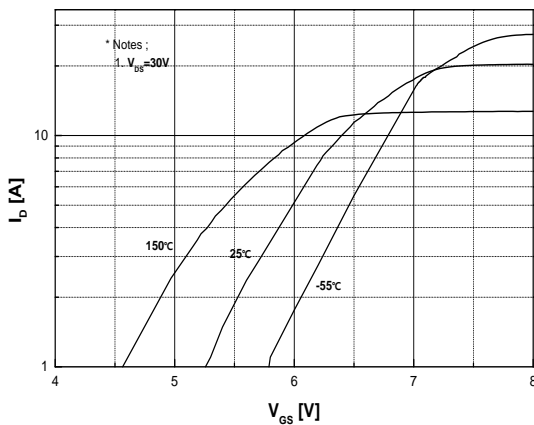

**Fig.5 Transfer Characteristics**

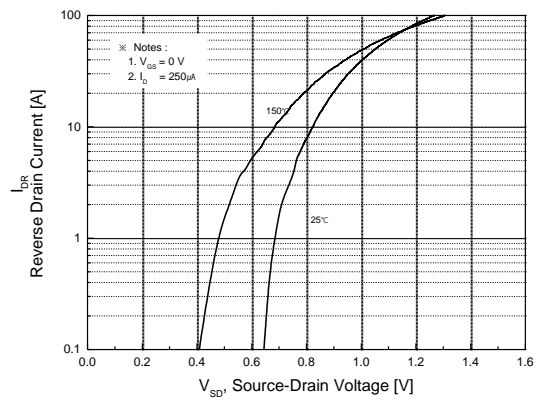

**Fig.6 Body Diode Forward Voltage Variation with Source Current and Temperature**

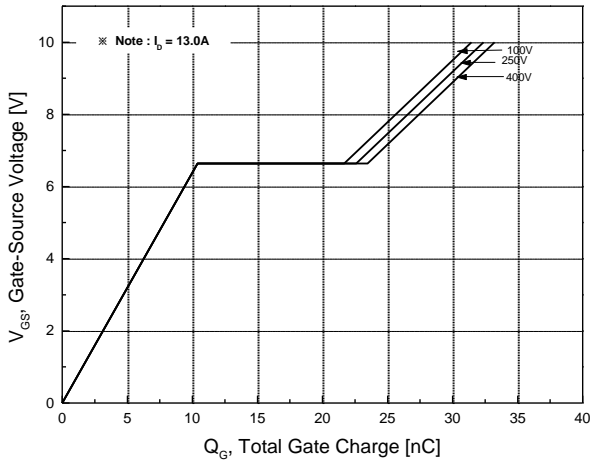

**Fig.7 Gate Charge Characteristics**

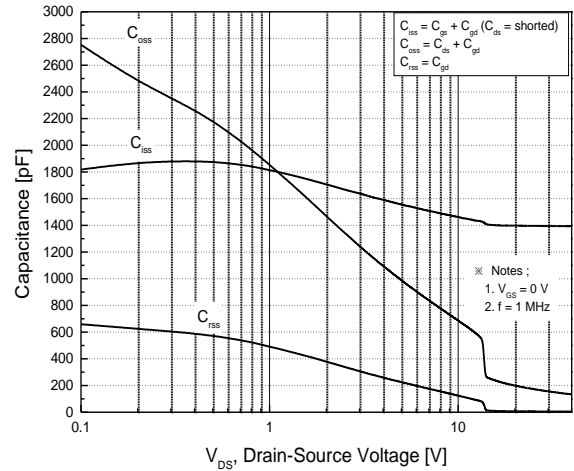

**Fig.8 Capacitance Characteristics**

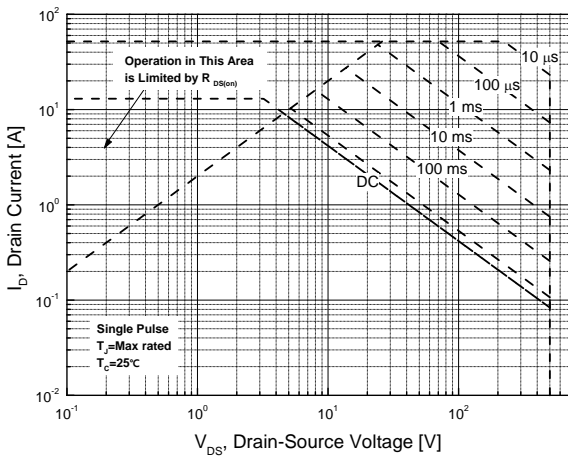

**Fig.9 Maximum Safe Operating Area**

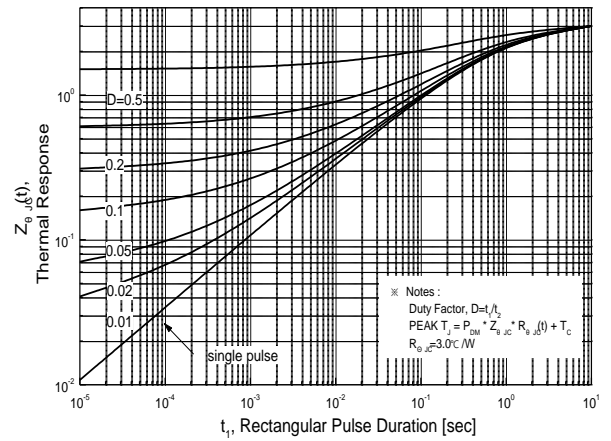

**Fig.10 Transient Thermal Response Curve**

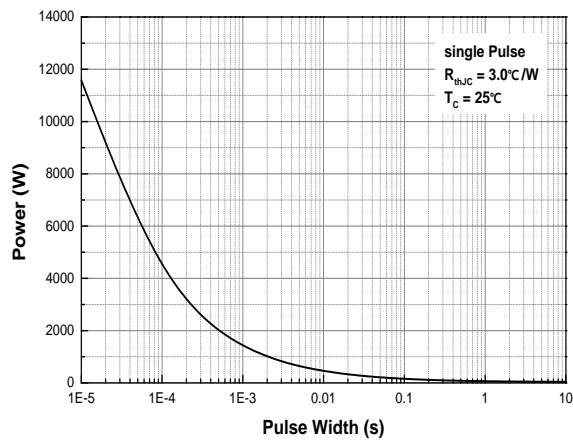

**Fig.11 Single Pulse Maximum Power Dissipation**

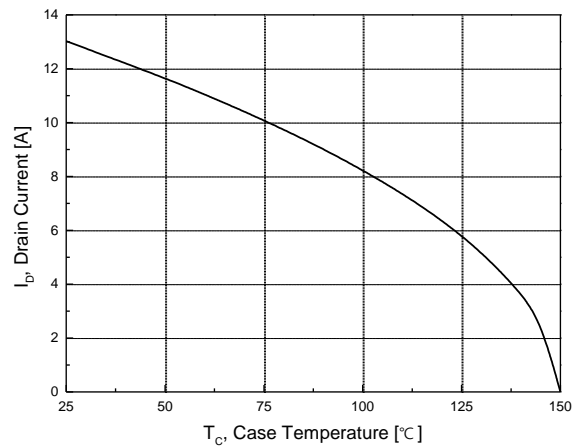
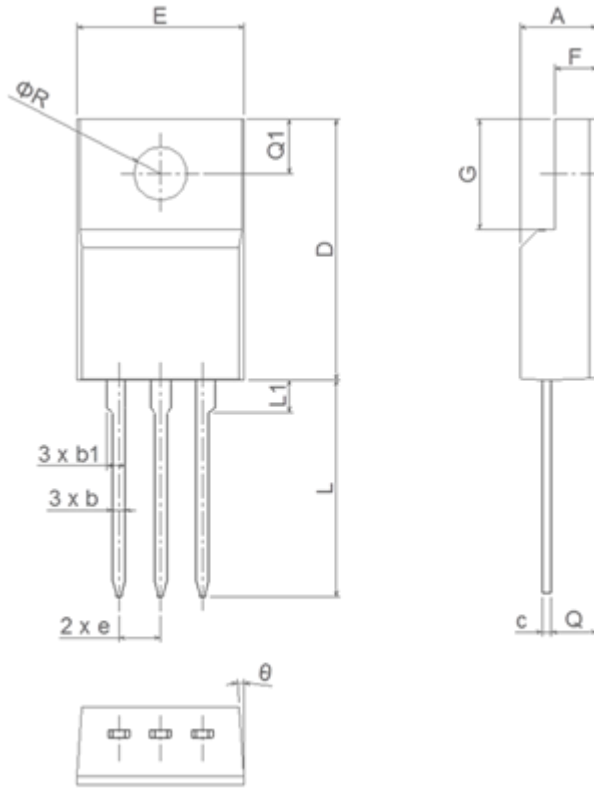

**Fig.12 Maximum Drain Current vs. Case Temperature**

## Physical Dimensions

### TO-220F(Thin lead frame)

Dimensions are in millimeters unless otherwise specified



Symbol	Dimension [mm]		
	Min	Nom	Max
A	4.30	-	4.90
b	0.54	-	0.86
b1	0.94	-	1.34
c	0.45	-	0.79
D	14.70	-	16.37
E	9.66	-	10.66
e	2.54 BSC		
F	2.40	-	2.90
G	6.50	-	7.10
L	12.43	-	13.50
L1	1.80	-	2.20
Q	2.50	-	2.86
Q1	2.70	-	3.40
ΦR	3.00	-	3.40
θ	0°	-	10°

**DISCLAIMER:**

The Products are not designed for use in hostile environments, including, without limitation, aircraft, nuclear power generation, medical appliances, and devices or systems in which malfunction of any Product can reasonably be expected to result in a personal injury. Seller's customers using or selling Seller's products for use in such applications do so at their own risk and agree to fully defend and indemnify Seller.

Magnachip reserves the right to change the specifications and circuitry without notice at any time. Magnachip does not consider responsibility for use of any circuitry other than circuitry entirely included in a Magnachip product.  Magnachip is a registered trademark of Magnachip Semiconductor Ltd.