

### General Description

The MDF7N50B uses advanced Magnachip's MOSFET Technology, which provides low on-state resistance, high switching performance and excellent quality.

MDF7N50B is suitable device for SMPS, high Speed switching and general purpose applications.

### Features

- $V_{DS} = 500V$
- $I_D = 7.0A$  @  $V_{GS} = 10V$
- $R_{DS(ON)} \leq 0.9\Omega$  @  $V_{GS} = 10V$

### Applications

- Power Supply
- PFC
- Ballast

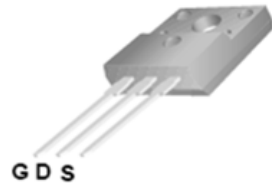

TO-220F  
MDF Series

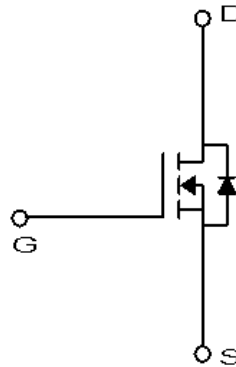

### Absolute Maximum Ratings (Ta = 25°C)

Characteristics		Symbol	Rating	Unit
Drain-Source Voltage		$V_{DSS}$	500	V
Gate-Source Voltage		$V_{GSS}$	±30	V
Continuous Drain Current	$T_C=25^\circ C$	$I_D$	7.0*	A
	$T_C=100^\circ C$		4.2*	A
Pulsed Drain Current <sup>(1)</sup>		$I_{DM}$	28*	A
Power Dissipation	$T_C=25^\circ C$	$P_D$	36	W
	Derate above 25 °C		0.29	W/°C
Repetitive Avalanche Energy <sup>(1)</sup>		$E_{AR}$	11.4	mJ
Peak Diode Recovery $dv/dt$ <sup>(3)</sup>		$dv/dt$	4.5	V/ns
Single Pulse Avalanche Energy <sup>(4)</sup>		$E_{AS}$	270	mJ
Junction and Storage Temperature Range		$T_J, T_{stg}$	-55~150	°C

※  $I_D$  limited by maximum junction temperature

### Thermal Characteristics

Characteristics	Symbol	Rating	Unit
Thermal Resistance, Junction-to-Ambient <sup>(1)</sup>	$R_{\theta JA}$	62.5	°C/W
Thermal Resistance, Junction-to-Case <sup>(1)</sup>	$R_{\theta JC}$	3.5	

## Ordering Information

Part Number	Temp. Range	Package	Packing	RoHS Status
MDF7N50BTH	-55~150°C	TO-220F	Tube	Halogen Free

## Electrical Characteristics (Ta = 25°C)

Characteristics	Symbol	Test Condition	Min	Typ	Max	Unit
<b>Static Characteristics</b>						
Drain-Source Breakdown Voltage	$BV_{DSS}$	$I_D = 250\mu A, V_{GS} = 0V$	500	-	-	V
Gate Threshold Voltage	$V_{GS(th)}$	$V_{DS} = V_{GS}, I_D = 250\mu A$	2.0	-	4.0	
Drain Cut-Off Current	$I_{DSS}$	$V_{DS} = 500V, V_{GS} = 0V$	-	-	1	$\mu A$
Gate Leakage Current	$I_{GSS}$	$V_{GS} = \pm 30V, V_{DS} = 0V$	-	-	100	nA
Drain-Source ON Resistance	$R_{DS(ON)}$	$V_{GS} = 10V, I_D = 3.5A$	-	0.76	0.9	$\Omega$
Forward Transconductance	$g_{fs}$	$V_{DS} = 30V, I_D = 3.5A$	-	7	-	S
<b>Dynamic Characteristics</b>						
Total Gate Charge	$Q_g$	$V_{DS} = 400V, I_D = 7.0A, V_{GS} = 10V^{(3)}$	-	14.9	-	nC
Gate-Source Charge	$Q_{gs}$		-	3.3	-	
Gate-Drain Charge	$Q_{gd}$		-	5.1	-	
Input Capacitance	$C_{iss}$	$V_{DS} = 25V, V_{GS} = 0V, f = 1.0MHz$	-	760	-	pF
Reverse Transfer Capacitance	$C_{rss}$		-	4.5	-	
Output Capacitance	$C_{oss}$		-	97	-	
Turn-On Delay Time	$t_{d(on)}$	$V_{GS} = 10V, V_{DS} = 250V, I_D = 7.0A, R_G = 25\Omega^{(3)}$	-	17	-	ns
Rise Time	$t_r$		-	30	-	
Turn-Off Delay Time	$t_{d(off)}$		-	98	-	
Fall Time	$t_f$		-	34	-	
<b>Drain-Source Body Diode Characteristics</b>						
Maximum Continuous Drain to Source Diode Forward Current	$I_S$		-	7.0	-	A
Source-Drain Diode Forward Voltage	$V_{SD}$	$I_S = 7.0A, V_{GS} = 0V$	-	-	1.4	V
Body Diode Reverse Recovery Time	$t_{rr}$	$I_F = 7.0A, di/dt = 100A/\mu s^{(3)}$	-	260	-	ns
Body Diode Reverse Recovery Charge	$Q_{rr}$		-	1.7	-	$\mu C$

Note :

- Pulse width is based on  $R_{\theta JC}$  &  $R_{\theta JA}$  and the maximum allowed junction temperature of 150°C.
- Pulse test: pulse width  $\leq 300\mu s$ , duty cycle  $\leq 2\%$ , pulse width limited by junction temperature  $T_{J(MAX)} = 150^\circ C$ .
- $I_{SD} \leq 7.0A$ ,  $di/dt \leq 200A/\mu s$ ,  $V_{DD} \leq BV_{DSS}$ ,  $R_G = 25\Omega$ , Starting  $T_J = 25^\circ C$
- $L = 10.0mH$ ,  $I_{AS} = 7.0A$ ,  $V_{DD} = 50V$ ,  $R_G = 25\Omega$ , Starting  $T_J = 25^\circ C$

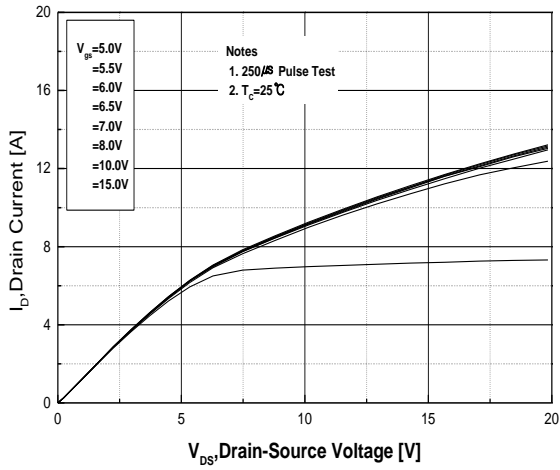

**Fig.1 On-Region Characteristics**

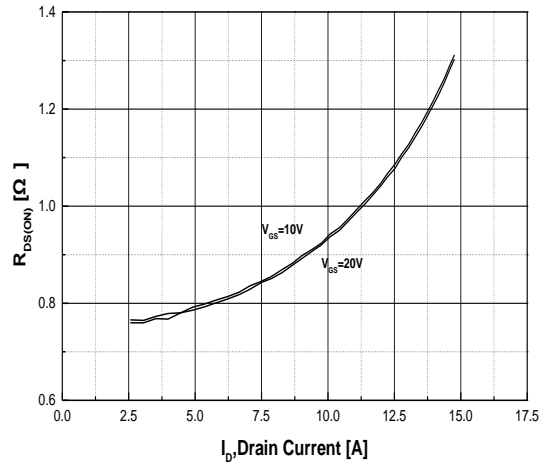

**Fig.2 On-Resistance Variation with Drain Current and Gate Voltage**

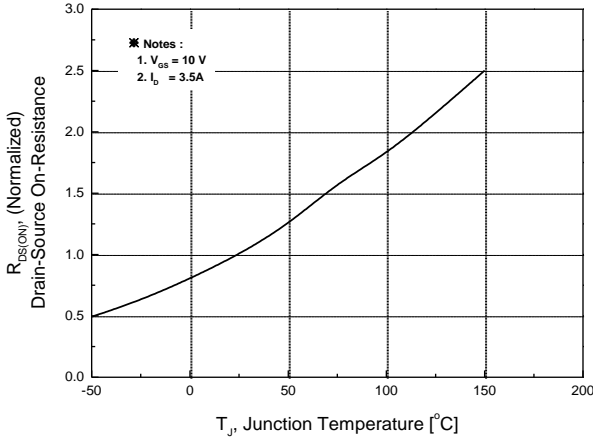

**Fig.3 On-Resistance Variation with Temperature**

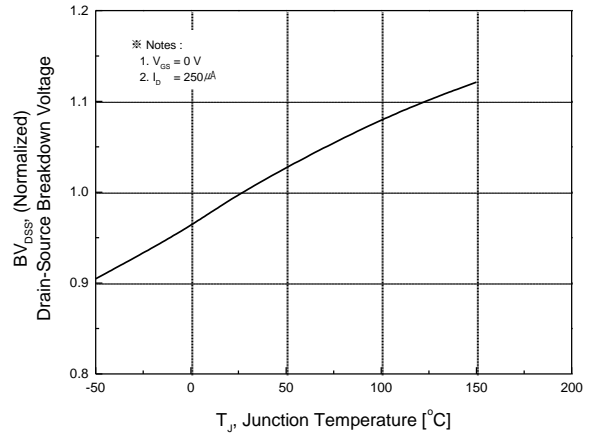

**Fig.4 Breakdown Voltage Variation vs. Temperature**

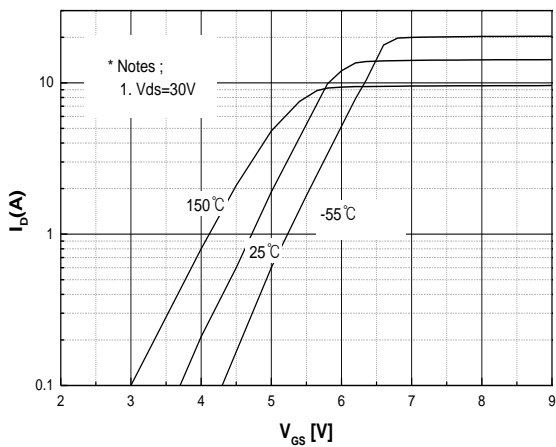

**Fig.5 Transfer Characteristics**

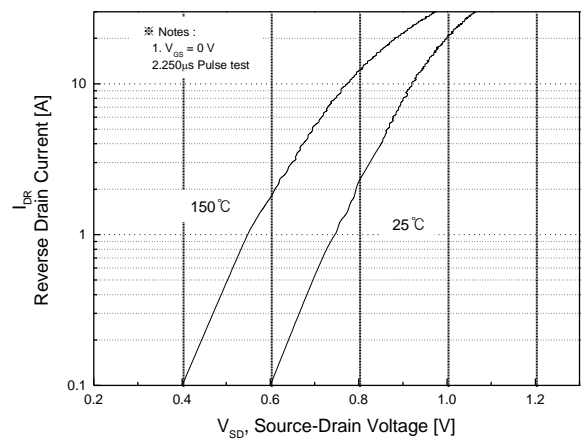

**Fig.6 Body Diode Forward Voltage Variation with Source Current and Temperature**

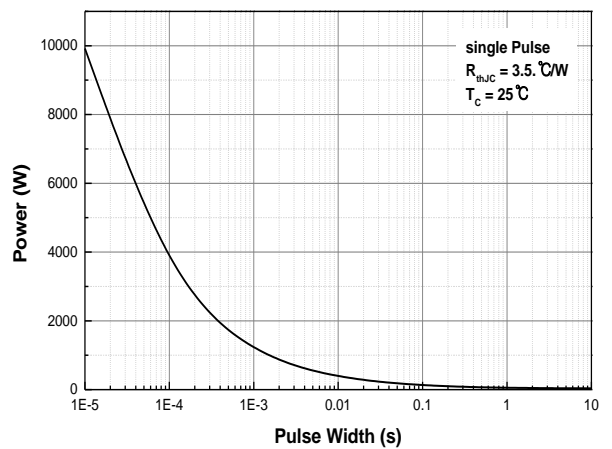
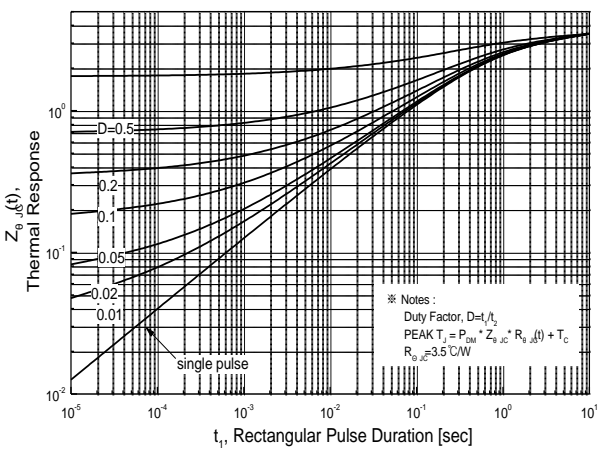
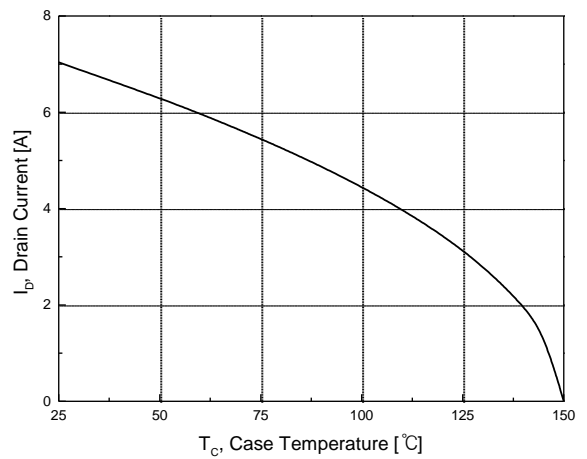
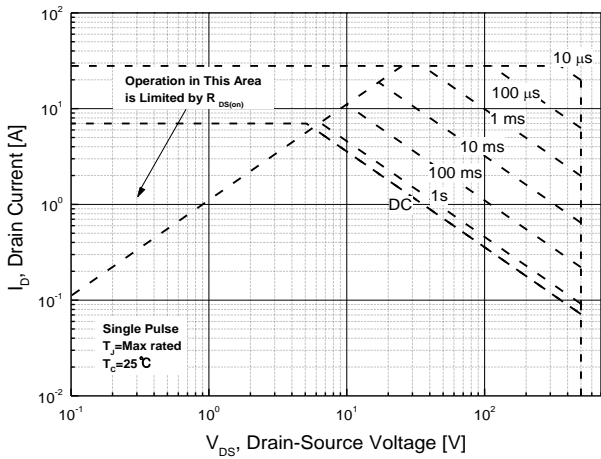
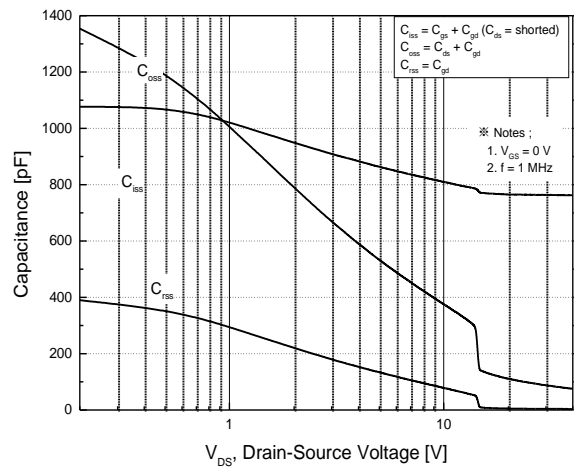
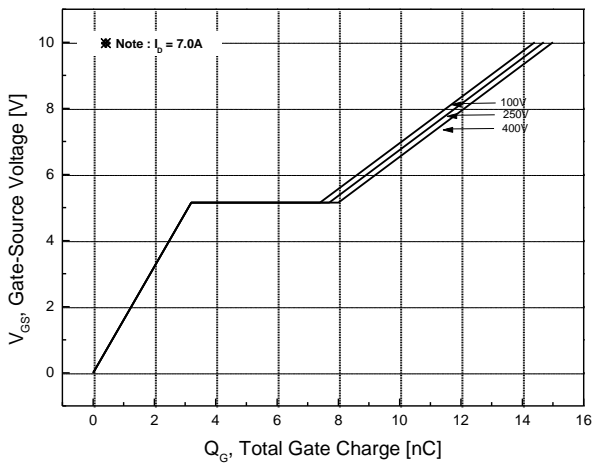

**Physical Dimension**

**3 Leads, TO-220F**

Dimensions are in millimeters unless otherwise specified

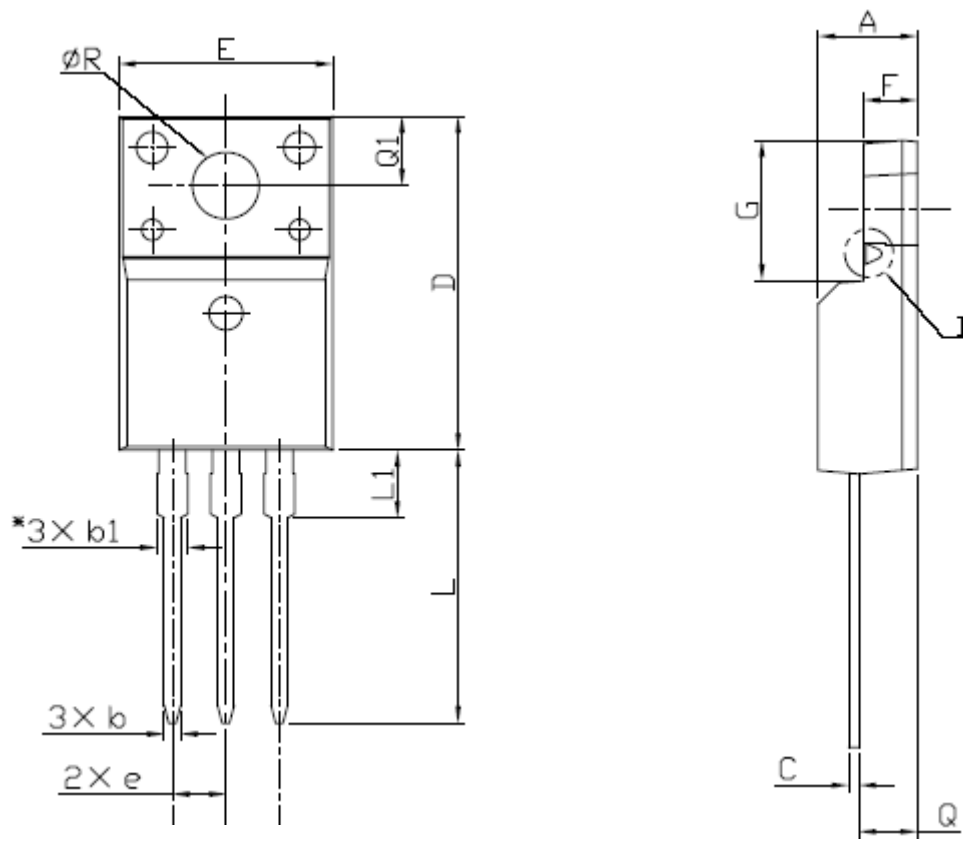

Symbol	Min	Nom	Max
A	4.50		4.93
b	0.63		0.91
b1	1.15		1.47
C	0.33		0.63
D	15.47		16.13
E	9.60		10.71
e		2.54	
F	2.34		2.84
G	6.48		6.90
L	12.24		13.72
L1	2.79		3.67
Q	2.52		2.96
Q1	3.10		3.50
$\phi R$	3.00		3.55

**DISCLAIMER:**

The Products are not designed for use in hostile environments, including, without limitation, aircraft, nuclear power generation, medical appliances, and devices or systems in which malfunction of any Product can reasonably be expected to result in a personal injury. Seller's customers using or selling Seller's products for use in such applications do so at their own risk and agree to fully defend and indemnify Seller.

MagnaChip reserves the right to change the specifications and circuitry without notice at any time. MagnaChip does not consider responsibility for use of any circuitry other than circuitry entirely included in a MagnaChip product.  is a registered trademark of MagnaChip Semiconductor Ltd.