



Datasheet - MAP3232

Dual Channel Switch Mode Operating LED Driver

MAP3232 – Dual Channel Switch Mode Operating LED Driver

General Description

MAP3232 is high efficiency dual channel boost type PWM driver in single package. It is designed for high brightness LED driver optimized for backlighting system for large size LCD module.

MAP3232 offers the function of accurate and fast LED dimming control using PWM interface and external dimming MOSFET.

MAP3232 has the over-voltage protection, UVLO, LED short current and Boost switch current limit protection. It has the power good indication as the interface with TV set

MAP3232 is available in SOIC-24 Pin package with Halogen-free (fully RoHS compliant).

For more information, please contact local MagnaChip sales office in world-wide or visit MagnaChip's website at www.magnachip.com.

Features

- Dual output into single package
- Wide input voltage range : 8.5V ~ 36V
- Dual PWM and Analog Dimming
- Current Mode Control Type
- Adjustable SW frequency : 100kHz ~ 500kHz
- 10V Gate Drive
- Reference voltage : 5.0V±1.0%
- Protections :
 Boost OCP, OVP, UVLO, LED Short, Boost Diode Open
- Programmable LED Short current Protection
- Boost switch current limit protection
- Auto-Restart Mode
- Power Good
- Package : SOIC-24 Pin

Applications

- High Brightness white LED backlighting for LCD TVs and monitors
- General LED lighting applications

Ordering Information

Part Number	Top Marking	Ambient Temperature Range	Package	RoHS Status
MAP3232SIRH	MAP3232	-40°C to +85°C	SOIC-24 Pin	Halogen Free

Typical Application

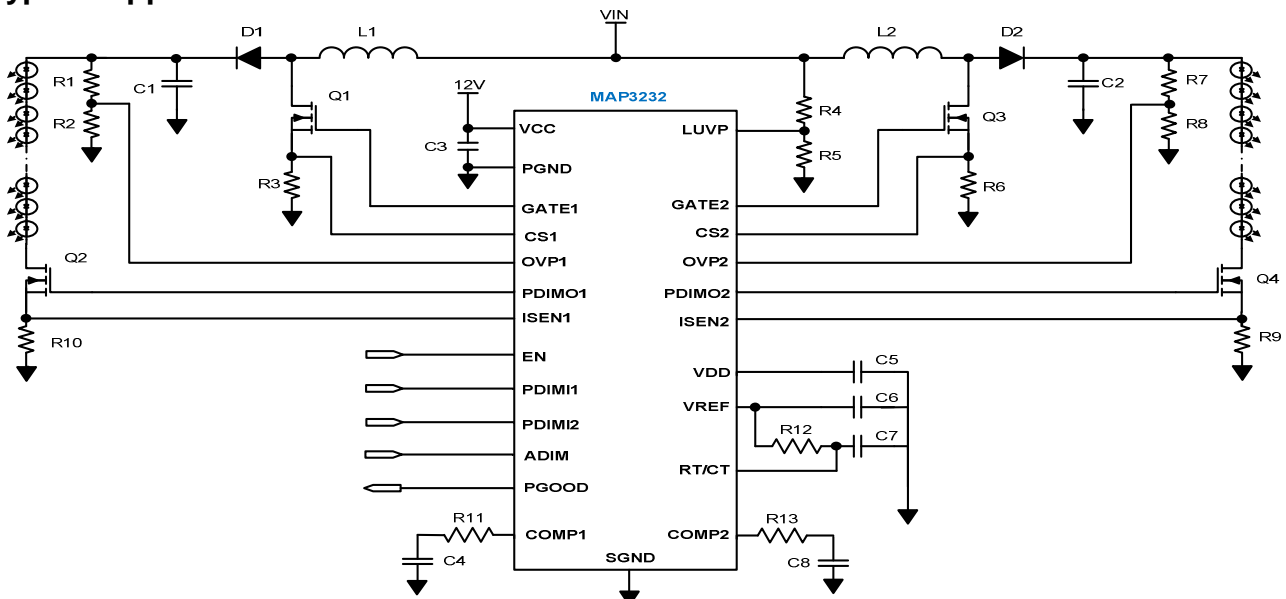

Pin Configuration

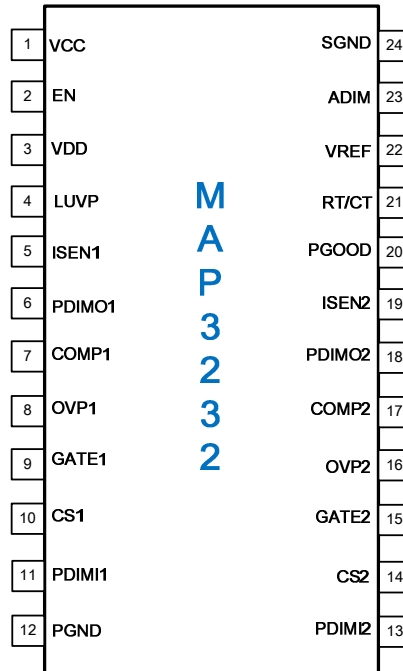

Pin Description

PIN NO	Description	
1	VCC	Power Supply Input
2	EN	Enable
3	VDD	Internal Regulator Output for Gate Drive
4	LUVP	Input Line Voltage Sense
5	ISEN1	Ch#1 LED Current Sense connected to Error Amp. Inverting Input
6	PDIMO1	Ch#1 Dimming PWM Gate Driver Output
7	COMP1	Ch#1 Error Amp. Compensation
8	OVP1	Ch#1 Over voltage protection
9	GATE1	Ch#1 Gate drive Output for Boost Convert
10	CS1	Ch#1 Current sense of the Boost Convert
11	PDIMI1	Ch#1 Dimming PWM Gate Driver Input
12	PGND	Power GND
13	PDIMI2	Ch#2 Dimming PWM Gate Driver Input
14	CS2	Ch#2 Current sense of the Boost Convert
15	GATE2	Ch#2 Gate drive Output for Boost Convert
16	OVP2	Ch#2 Over voltage protection
17	COMP2	Ch#2 Error Amp. Compensation
18	PDIMO2	Ch#2 Dimming PWM Gate Driver Output
19	ISEN2	Ch#2 LED Current Sense connected to Error Amp. Inverting Input
20	PGOOD	Power Good Indication (Open-Drain status output, Normal : Open, Protection : Internal GND)
21	RT/CT	Oscillator frequency setting
22	VREF	Reference voltage
23	ADIM	Analog Dimming for Ch#1 and Ch#2
24	SGND	Signal GND

Functional Block Diagram

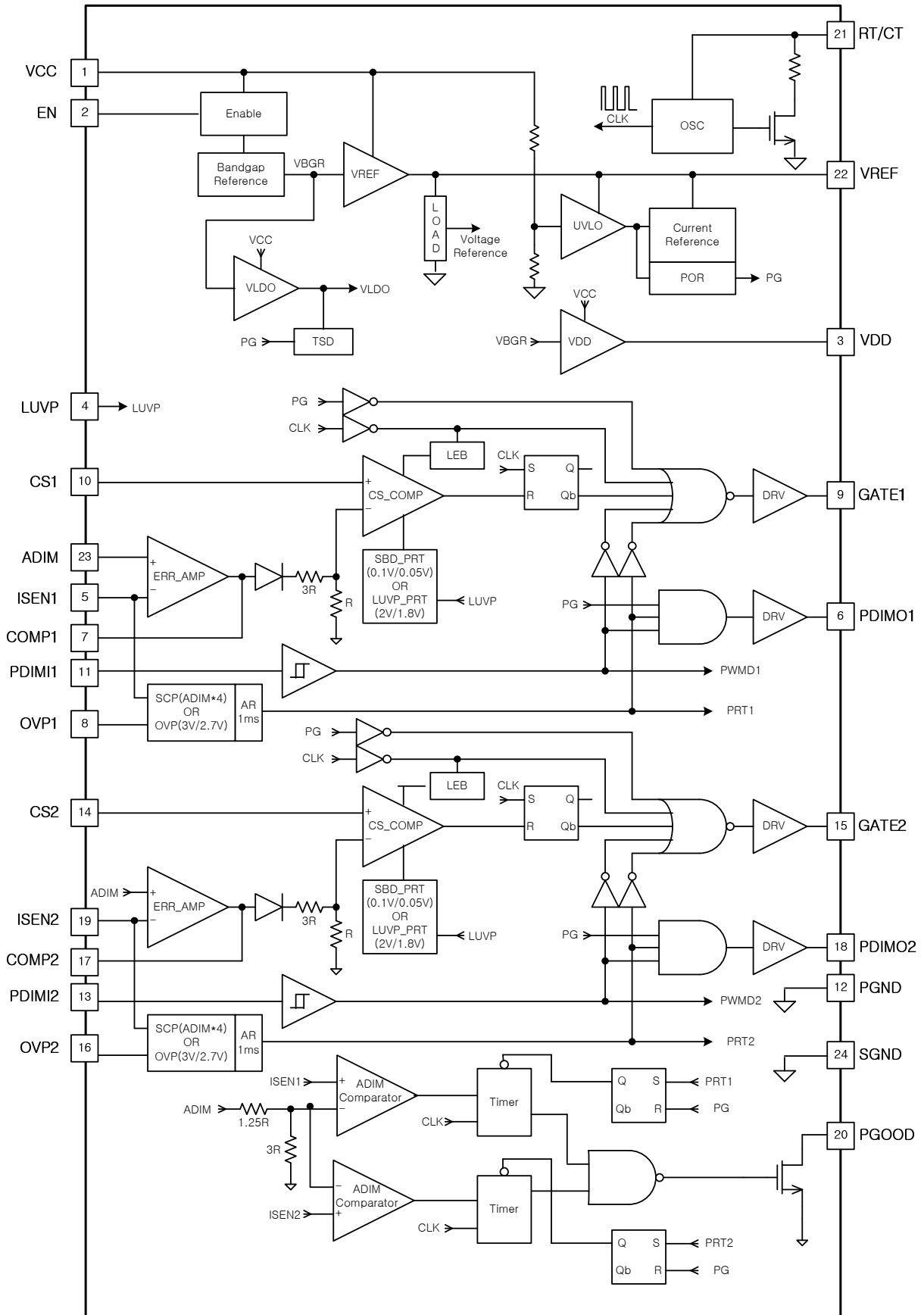

Absolute Maximum Ratings

PARAMETER	VALUE	UNIT
VCC	-0.3 ~ 40	V
GATE1/2, PDIMO1/2, PDIMI1/2, LUVF, VDD, EN, ADIM	-0.3 ~ 12	V
CS1/2, COMP1/2, ISEN1/2, OVP1/2, VREF, RT/CT, PGOOD	-0.3 ~ 5.5	V
Operating Junction Temperature Range	-40 ~ 125	°C
Storage Temperature Range	-65 ~ 150	°C
Lead temperature(soldering, 10sec)	260	°C
Thermal Resistance (θJA)	56.8	°C/W

Electrical Characteristics

$V_{CC}=12V$, $V_{PDIMI}=5V$, $C_{GATE}=C_{PDIMO}=1nF$, $T_a=25^{\circ}C$, unless otherwise specified

SYMBOL	PARAMETER	TEST CONDITION	MIN	TYP	MAX	UNIT
SUPPLY						
$V_{CC,OP}$	Input voltage range	$T_a = -40^{\circ}C \sim 85^{\circ}C$	8.5	-	36	V
I_Q	Operation quiescent current	PDIMI 1/2 = 0V	-	3	5	mA
I_{OP}	Operation Current	PDIMI 1/2 = 5V	-	-	20	mA
V_{UVLO}	Under-voltage lockout release threshold	-	7.3	7.8	8.3	V
	Under-voltage lockout hysteresis	-	-	0.5	-	V
Enable						
V_{EN}	Enable Input Voltage on EN Pin	$V_{EN,L}$: Logic Low	-	-	0.8	V
		$V_{EN,H}$: Logic High	2.0	-	-	V
I_{EN}	Enable Input Current on EN Pin	$V_{EN} = 0V$	-	2.0	4.0	μA
R_{Enable}	Enable pull-down resistance	-	250	500	1000	K Ω
VREF & VDD						
V_{REF}	Reference pin voltage	$T_a = -40^{\circ}C \sim 85^{\circ}C$, No load	4.90	5.00	5.10	V
		$T_a = 25^{\circ}C$, No load	4.95	5.00	5.05	V
V_{REFLI}	Line regulation	$I_{REF} = 0\mu A$, PDIMI = 0V, $C_{REF} = 0.1\mu F$	-	-	0.02	%/V
V_{REFLO}	Load regulation	$I_{REF} = 0\sim 500\mu A$, PDIMI = 0V, $C_{REF} = 0.1\mu F$	-	-	1	%/mA
V_{VDD}	VDD pin voltage	$T_a = 25^{\circ}C$, No load	9.0	10	11.5	V
Oscillator						
F_{OSC}	Oscillator frequency	$R_{RT} = 20K\Omega$, $C_{CT} = 390pF$, $T_a = 25^{\circ}C$	180	200	220	kHz
D_{MAX}	Maximum duty cycle	-	-	90	-	%
GATE (CH1, CH2)						
I_{SOURCE}	Gate short circuit current	$V_{GATE} = 0$, $V_{CC} = 12V$	0.03	0.06	-	A
I_{SINK}	Gate sink current	$V_{GATE} = 10V$, $V_{CC} = 12V$	0.15	0.3	-	A
T_{RISE}	GATE output rise time	$C_{GATE} = 1nF$, $V_{CC} = 12V$	-	50	100	nS
T_{FALL}	GATE output fall time	$C_{GATE} = 1nF$, $V_{CC} = 12V$	-	25	50	nS

Electrical Characteristics (Continued)

$V_{CC}=12V$, $V_{PDIM1}=5V$, $C_{GATE}=C_{PDIMO}=1nF$, $T_a=25^{\circ}C$, unless otherwise specified

SYMBOL	PARAMETER	TEST CONDITION	MIN	TYP	MAX	UNIT
Current Sense (CH1, CH2)						
T_{BLANK}	Leading Edge Blanking	-	100	-	375	nS
T_{DELAY}	Delay to output of CS comparator(2)	$V_{COMP} = 5V$ $V_{CS} = 0V$ to 600mV step pulse	-	-	180	nS
$V_{CS,MAX}$	Maximum CS Voltage	$V_{CC} = 12V$, $V_{ADIM} - V_{ISEN} > 0.2$	0.445	0.47	0.495	V
Internal Transconductance Opamp (CH1, CH2)						
A_v	Open loop DC Gain(2)	-	-	50	-	dB
V_{CM}	Input common-mode range	-	0.1	-	3.0	V
V_o	Output Voltage Low Limit	$V_{CC} = 12V$, $V_{ISEN} - V_{ADIM} > 0.2$	-	0.65	-	V
	Output Voltage High Limit	$V_{CC} = 12V$, $V_{ADIM} - V_{ISEN} > 0.2$	-	2.65	-	V
G_m	Transconductance(2)	-	400	670	1000	$\mu A/V$
I_{BIAS}	Input Bias current	-	-	0.5	1	nA
Internal Transconductance Opamp (CH1, CH2)						
V_{OFFSET}	Input Offset voltage	-	-5	-	5	mV
I_{AMP_SOURCE}	AMP Source Current	$V_{ISEN} = 1V$, $V_{ADIM} = 2V$, $V_{COMP} = 1.5V$	-	-120	-	μA
I_{AMP_SINK}	AMP Sink Current	$V_{ISEN} = 2V$, $V_{ADIM} = 1V$, $V_{COMP} = 1.5V$	-	120	-	μA
Dimming PWM Input (CH1, CH2)						
$V_{PDIM1(LO)}$	PDIM1 input Low voltage	-	-	-	0.8	V
$V_{PDIM1(HI)}$	PDIM1 input High voltage	-	2.0	-	-	V
R_{PDIM1}	PDIM1 pull-down resistance	$V_{PWM1} = 5V$	250	500	1000	K Ω
Dimming PWM Output (CH1, CH2)						
$T_{RISE,PDIMO}$	PDIMO Output rise time	1nF capacitance at PDIMO	-	-	300	nS
$T_{FALL,PDIMO}$	PDIMO Output fall time	1nF capacitance at PDIMO	-	-	200	nS
Over Voltage Protection (OVP)						
V_{OVP}	Over voltage protection	-	2.98	3.05	3.12	V
V_{OVPH}	Over voltage protection hysteresis		-	0.3	-	V
T_{OVP}	OVP Filtering time(2)		-	200	-	nS

Electrical Characteristics (Continued)

 $V_{CC}=12V$, $V_{PDIM1}=5V$, $C_{GATE}=C_{PDIM0}=1nF$, $T_a=25^{\circ}C$, unless otherwise specified

SYMBOL	PARAMETER	TEST CONDITION	MIN	TYP	MAX	UNIT
Short current protection (SCP)						
$V_{TH,SCP}$	SCP Comparator threshold voltage	$V_{ADIM} = 0.8V$ ($V_{TH,SCP} = V_{ADIM} * 4$)	2.88	3.2	3.52	V
V_{SCP}	SCP Comparator input range	-	1.6	-	4.0	V
T_{OFF}	Propagation time for short current detection (2)	$V_{ADIM} = 1V$, $V_{ISEN} = 2.5$ to $4V$ step V_{PDIM0} goes from high to low	-	-	250	nS
Line Under Voltage Protection (LUVP)						
V_{LINE}	Line voltage protection	-	1.73	1.85	1.97	V
V_{LINEH}	Line voltage protection release voltage	-	-	2.05	-	V
T_{LUVP}	LUVP Filtering time(2)	-	-	200	-	nS
R_{LUVP}	LUVP pull-down resistance	-	250	500	1000	K Ω
Auto Restart Protection (OVP & SCP)						
T_{AR}	Auto restart	@ $F_{OSC} = 200kHz$	-	1	-	mS
Boost Diode Open Protection (DOP)						
V_{DIODE_OPEN}	Diode Open Protection Level on OVP Pin	Rising Voltage Limit on OVP Pin	-	0.1	-	V
		Hysteresis, ΔV_{DIODE_OPEN}	-	0.05	-	V
Power Good Indication – Open Drain (Normal : Open, Abnormal : Internal GND)						
R_{PGOOD}	Power Good on resistance (2)	$V_{PGOOD} = 0.1V$	-	10	-	Ω
Soft-Start						
T_{SS}	Time for internal soft-start	@ $F_{OSC} = 200kHz$	-	10	-	mS
TSD						
T_{SD}	Thermal Shutdown Temperature	Shutdown Temperature	-	150	-	$^{\circ}C$
		Hysteresis, ΔT_{SD}	-	25	-	

Note 1: Stress beyond the maximum ratings listed above may incur permanent damage to the device. Operating above the recommended conditions for extended time may stress the device and affect device reliability. Also the device may not operate normally above the recommended operating conditions. These are stress ratings only.

Note 2: These parameters, although guaranteed by design, are not tested in mass production.

Typical Operating Characteristics

Unless otherwise noted, $V_{CC} = 12V$, $V_{DIM} = 5V$

Quiescent Current vs. Temp

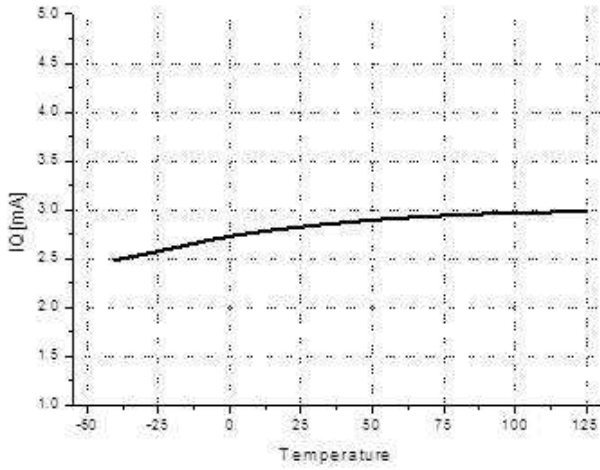

Operation Current vs. Temp

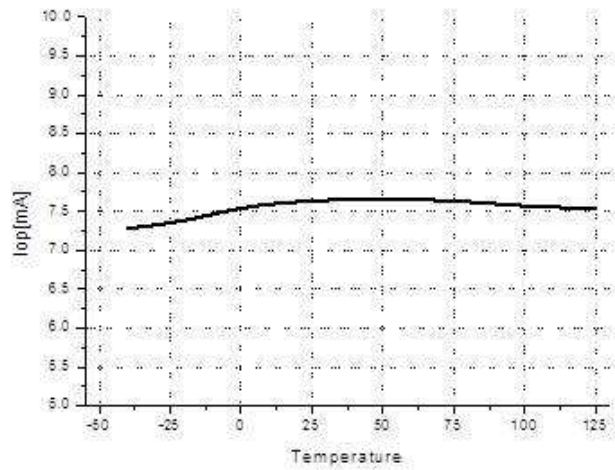

VREF vs. Temp

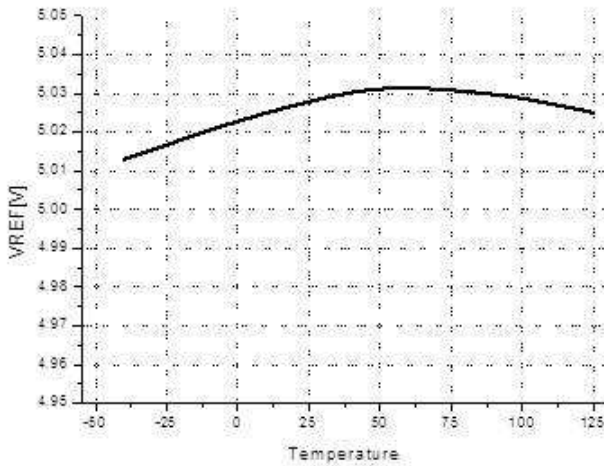

VDD vs. Temp

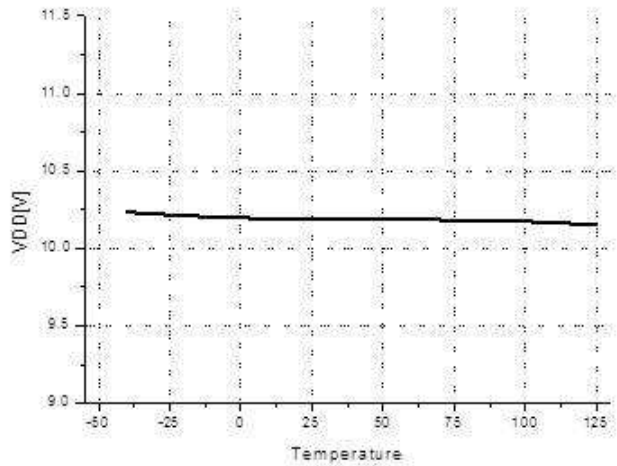

SCP vs. Temp

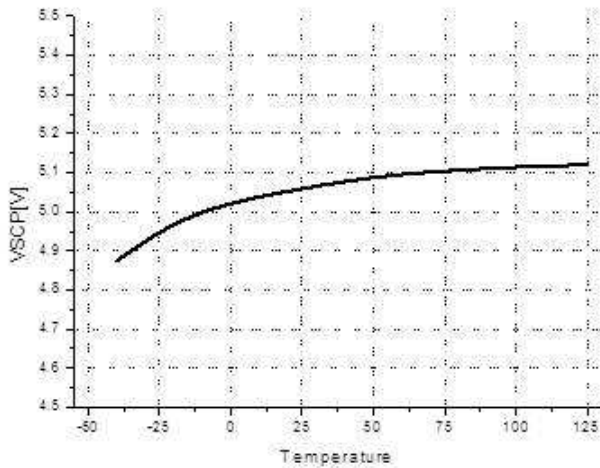

OVP vs. Temp

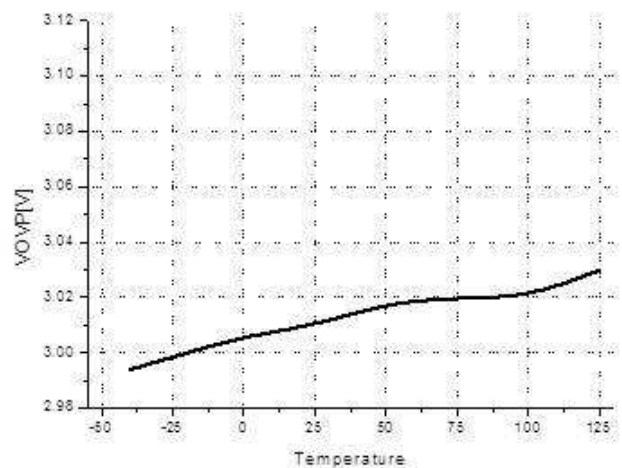

Typical Operating Characteristics (Continued)

Unless otherwise noted, $V_{CC} = 12V$, $V_{PDIM} = 5V$

LUV_P vs. Temp

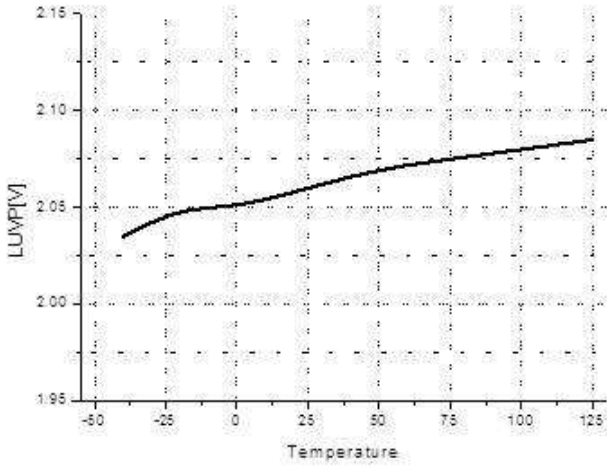

DOP vs. Temp

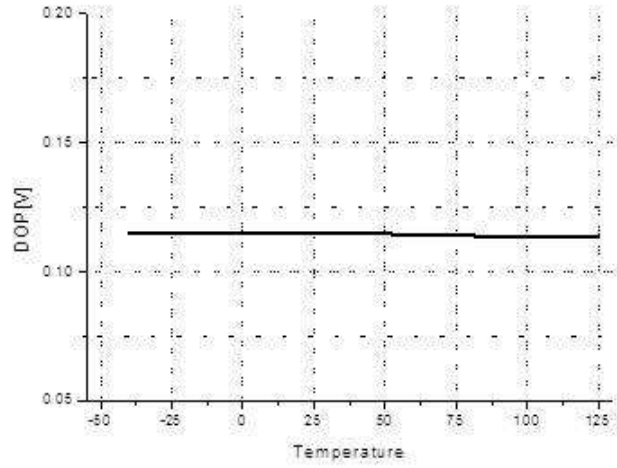

V_{cs_Max} vs. Temp

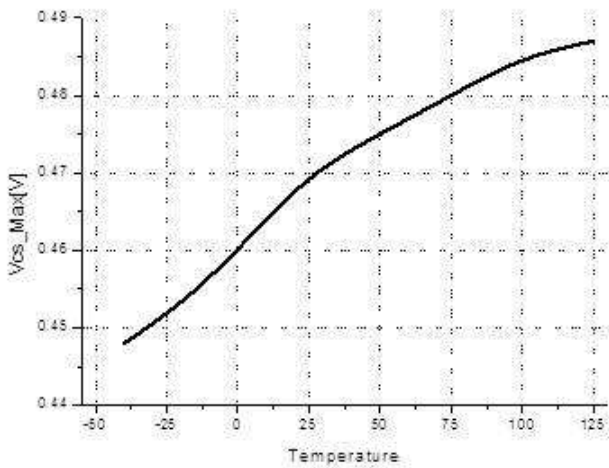

Application Information

MAP3232 has an independent dual channel Boost type LED driver. So, it can be controlled independently.

Current Mode Boost switching regulator operation

MAP3232 is being used Current mode control scheme for boost regulation so its response is fast and output voltage is stable.

Supply voltage and Oscillator

MAP3232 has wide input voltage ranged from 8.5V to 36V. 1uF decoupling capacitor is used to stabilize the internal regulator and minimize noise on Vcc pin. This decoupling capacitor should be placed next to Vcc pin. Ceramic capacitor is recommended and incorrect placement of this decoupling capacitor may cause the oscillation in the switching waveform

MAP3232 is being operated at adjustable Switching frequency.(100khz ~ 500khz) and max duty is 90%.

The following is the equation to calculate frequency setting.

$$F_s(\text{Khz}) = \frac{1.7}{(R_{RT} + 2000) \times C_{CT}}$$

We recommend R_{RT} Value is over 20Kohm. This equation is for your reference. We need to some modify value (R_{RT} and C_{CT}) for actual board.

LED Current Input setting (ADIM Input)

MAP3232's LED current is set by the voltage on ADIM pin and LED sense resistor value as below.

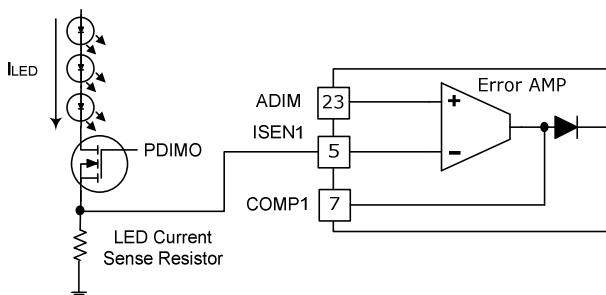

Fig 1. Schematic for LED current set

$$I_{LED} = \frac{V_{ADIM}}{LED_Current_Sense_R}$$

The voltage range on ADIM pin is 0.1V ~ 3.0V. But it is recommended that ADIM Input voltage is higher than 0.4V.

The Error Amp Input V_{OFFSET} is $\pm 5mV$. If ADIM voltage use to below 0.4V, LED current tolerance is increases.

Dimming PWM Input

MAP3232's PDIMI signal is used for both Enable and PWM dimming input. MAP3232 is enabled when PDIMI voltage is higher than 2.0V and disabled when PDIMI voltage is lower than 0.8V. This pin has internal 500Kohm pull down resistance

PWM Input	Condition
High (2.0V)	Enable
Low (0.8V)	Disable

Enable Input

MAP3232's offers an Enable Function. MAP3232 is enabled when EN voltage is higher than 2.0V and disabled when EN voltage is lower than 0.8V. This pin has internal 500Kohm pull down resistance

EN Input	Condition
High (2.0V)	Enable
Low (0.8V)	Disable

Protection

MAP3232 has Under Voltage Lock Out (UVLO), Boost switch current limit, Output Over Voltage Protection (OVP), Line Under Voltage Protection(LUVP), LED Short Current Protection(SCP), Boost Diode Open Protection (DOP). When OVP and LED SCP are happened, MAP3232 monitors if the failure condition is released or not every 1mS at F_s 200Khz.

This is MAP3232's Auto restart function.

1. Under Voltage Lock Out (UVLO)

When Vcc is higher than 8.0V, MAP3232's internal 5V regulator and internal circuitry like oscillator, protections, Gate drivers and PDIMO drivers are enabled, and the MAP3232 starts to operate when PDIMI voltage and EN signal are higher than 2.0V.

If Vcc is lower than 7.0V, MAP3232 is disable due to it's Under voltage lock out.

2. Boost current limit and Current Sense (CS)

MAP3232 has the Boost current limit function. If the voltage on CS pin is higher than 0.47V (Typ.), the gate pulse is limited every pulse. MAP3232 has 100nS (Min.) leading edge blank.

3. Output Over Voltage Protection (OVP)

When MAP3232's output voltage is increased abnormally, MAP3232 stops the switching to protect external components.

MAP3232 has 200nS (Typ.) low pass filter on OVP pin, but using external Capacitor is recommended to minimize noise. The total values of R_{OVPH} and R_{OVPL} need to be lower than 1Mohm.

OVP threshold voltage is 3.0V and OVP voltage can be set as below.

- OVP set voltage :

$$V_o = 3.0 \times \frac{R_{OVPH} + R_{OVPL}}{R_{OVPL}}$$

- OVP release voltage :

$$V_o = 2.7 \times \frac{R_{OVPH} + R_{OVPL}}{R_{OVPL}}$$

4. Line Under Voltage Protection (LUVPL)

When Line voltage is low voltage input, to prevent the stress of the transition for power component, MAP3232 stops the switching to protect external components.

MAP3232 has 200nS (Typ.) low pass filter on LUVPL pin, but using external Capacitor is recommended to minimize noise. The total values of R_{LUVPH} and R_{LUVPL} need to be lower than 1Mohm.

LUVPL threshold voltage is 2.0V and LUVPL voltage can be set as below.

- LUVPL set voltage :

$$V_{IN} = 1.8 \times \frac{R_{LUVPH} + R_{LUVPL}}{R_{LUVPL}}$$

- LUVPL release voltage :

$$V_{IN} = 2.0 \times \frac{R_{LUVPH} + R_{LUVPL}}{R_{LUVPL}}$$

5. LED Short Current Protection (SCP)

To protect external components, MAP3232 has the LED short protection. If the LED SCP threshold voltage changes based on ADIM voltage as below, so if ISEN voltage is higher than LED SCP threshold voltage, MAP3232 will be in LED SCP mode disabling gate for boost MOSFET and dimming MOSFET.

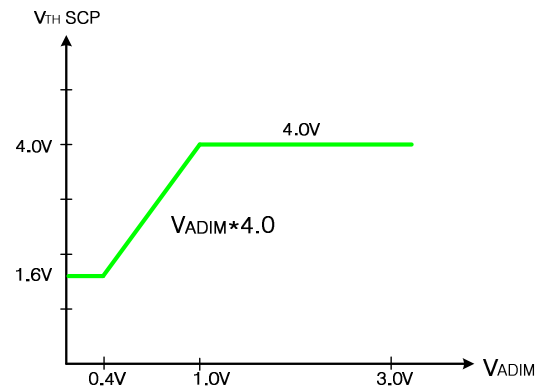

Fig 2. SCP threshold voltage based on ADIM voltage

6. Auto-Restart Protection

The MAP3232 offers Auto Restart protection function which is recovered into normal operation mode when protection condition is cleared. The auto restart time (T_{AR}) is 1mS at F_s 200Khz.

It is recovered to normal operating mode if SCP or OVP condition is cleared.

7. Boost Diode Open Protection (DOP)

When OVP pin voltage is less than 0.1V, a corresponding comparator turns off the external MOSFET.

This protects the driver from damage if the output Boost diode is open (defective or poor solder contact).

8. Power Good (PGOOD)

MAP3232 has the PGOOD pin to send out the LED current status. PGOOD will be high when the LED current is higher than 70% of normal LED current.

1) Power Good scheme at OVP Protection.

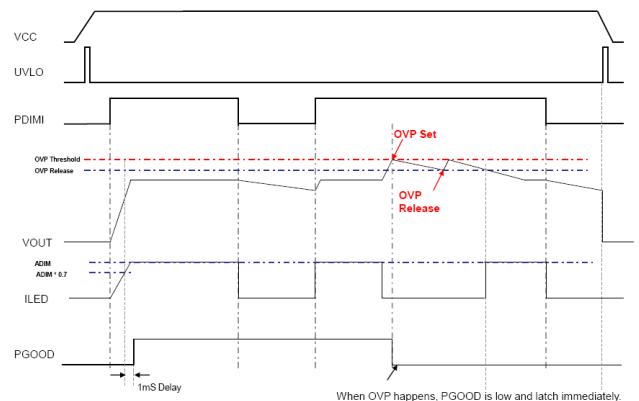

When OVP happens, PGOOD is low and latch immediately.

PGOOD reset should be only shut down of IC Vcc or EN Signal

2) Power Good scheme at SCP Protection.

Loop Compensation

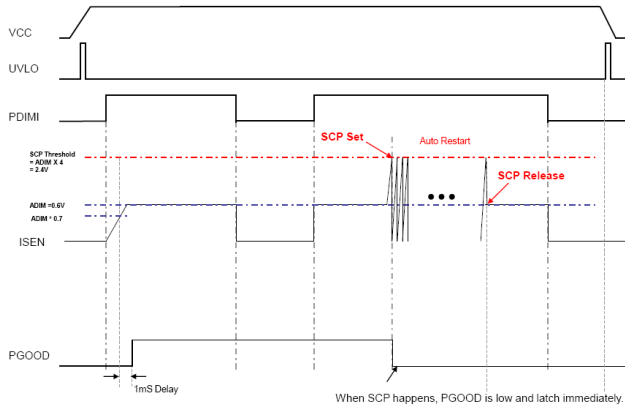

The MAP3232 controls in current mode. Current mode easily achieves compensation by consisting simple single Pole from Double Pole that LC filter makes at Voltage mode

In general, crossover frequency is selected from 1/3 ~ 1/6 range of the switching frequency. If f_c is large, there is possibility of oscillation to occur, although time response gets better. On the other hand, if f_c is small, time response will be bad, while it has improved stability, which may cause over shoot or under shoot in abnormal condition.

When SCP happens, PGOOD is low and latch immediately. PGOOD reset should be only shut down of IC Vcc or EN signal.

3) PGOOD Pull up resistance is recommending over than 100Kohm.

Inductor Selection

Inductor value should be decided before system design. Because the selection of the inductor affects the operating mode of CCM (Continuous current mode) or DCM (Discontinuous current mode), In CCM operation, inductor size should be bigger, even though the ripple current and peak current of inductor can be small. In DCM operation, even ripple current and peak current of inductor should be large while the inductor size can be smaller so that it is more effective in BLU of TV and Notebook application.

The following is the equation to calculate max value of Inductor.

$$L_{(critical)} = \frac{(1-D)^2 \times D \times R_{O(max)} \times T_{S(min)}}{2}$$

Where,

$R_{O(max)}$ = Maximum output impedance
 $T_{S(min)}$ = Minimum Switching Period

$L_{(Inductance)} > L_{(critical)} \rightarrow$ CCM
 $L_{(Inductance)} < L_{(critical)} \rightarrow$ DCM

$$D = 1 - \frac{V_{IN}}{V_{OUT}}, \quad R_{O(max)} = \frac{V_{OUT}}{I_{OUT}}, \quad T_{S(min)} = \frac{1}{F_S}$$

Physical Dimensions

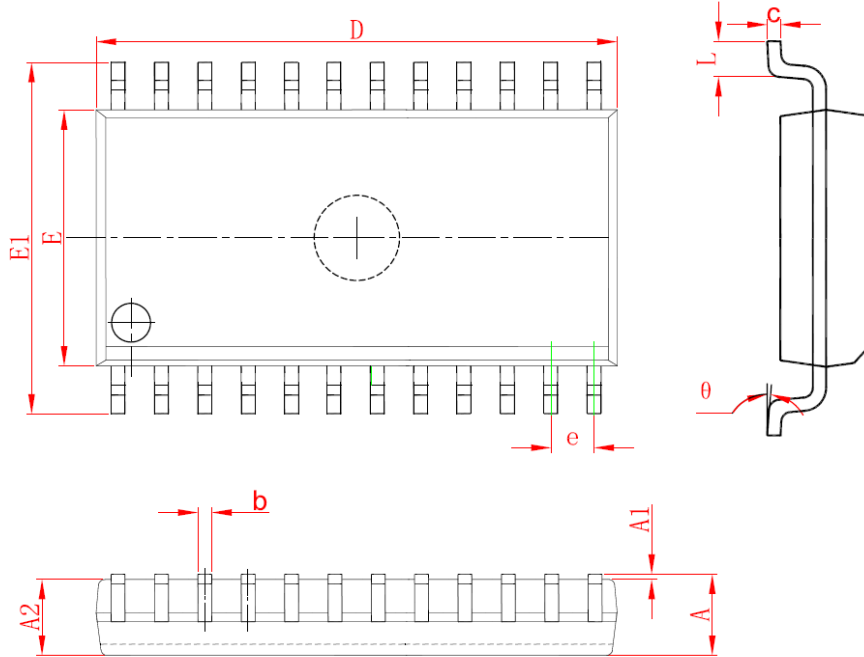

Symbol	Dimensions In Millimeters		Dimensions In Inches	
	Min	Max	Min	Max
A	2.350	2.650	0.093	0.104
A1	0.100	0.300	0.004	0.012
A2	2.100	2.500	0.083	0.098
b	0.330	0.510	0.013	0.020
c	0.204	0.330	0.008	0.013
D	15.200	15.600	0.598	0.614
E	7.400	7.600	0.291	0.299
E1	10.210	10.610	0.402	0.418
e	1.270 (BSC)		0.050 (BSC)	
L	0.400	1.270	0.016	0.050
θ	0°	8°	0°	8°

MagnaChip Semiconductor Ltd. doesn't not recommend the use of its products in hostile environments, including, without limitation, aircraft, nuclear power generation, medical appliances, and devices or systems in which malfunction of any product can reasonably be expected to result in a personal injury. Seller's customers using or selling Seller's products for use in such applications do so at their own risk and agree to fully defend and indemnify Seller.
MagnaChip reserves the right to change the specifications and circuitry without notice at any time. **MagnaChip** does not consider responsibility for use of any circuitry other than circuitry entirely included in a **MagnaChip** product.

MagnaChip[®] is a registered trademark of MagnaChip Semiconductor Ltd.

MagnaChip Semiconductor Ltd.

891, Daechi-Dong, Kangnam-Gu, Seoul, 135-738 Korea

Tel : 82-2-6903-3451 / Fax : 82-2-6903-3668 ~9

www.magnachip.com

Revision History

Date	Version	Changes
2012-11-20	Version 0.0	Initial release.