

### General Description

Ultra-FRD module devices are optimized to reduce losses and EMI/RFI in high frequency power conditioning electrical systems. These diode modules are ideally suited for power converters, motors drives and other applications where switching losses are significant portion of the total losses.

### Features

- Repetitive Reverse Voltage :  $V_{RRM}=1200V$
- Low Forward Voltage :  $V_F(\text{typ.}) = 2.2V$
- Average Forward Current :  $I_F(\text{Av.})=75A @T_C=100^\circ C$
- Ultra-Fast Reverse Recovery Time :  $t_{rr}(\text{typ.}) = 30ns$
- Extensive Characterization of Recovery Parameters
- Reduced EMI and RFI
- Isolation Type Package

### Applications

- High Speed & High Power converters, Welders
- Various Switching and Telecommunication Power Supply

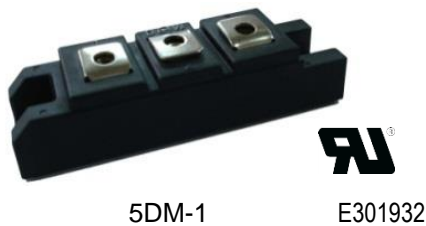

Side Common

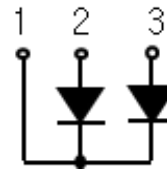

### Absolute Maximum Ratings @Tc = 25°C (Per Leg)

Characteristics	Conditions	Symbol	Rating	Unit	
Repetitive Peak Reverse Voltage		$V_{RRM}$	1200	V	
Reverse DC Voltage		$V_{R(DC)}$	960	V	
Average Forward Current	Resistive Load	$I_{F(AV)}$	$T_C=25^\circ C$	150	A
			$T_C=100^\circ C$	75	A
Surge(non-repetitive) Forward Current	One Half Cycle at 60Hz, Peak Value	$I_{FSM}$	1500	A	
$I^2t$ for Fusing	Value for One Cycle Current, $t_w = 8.3ms, T_J = 25^\circ C$ Start	$I^2t$	$9.34 * 10^3$	A <sup>2</sup> s	
Junction Temperature		$T_J$	-40 ~ 150	°C	
Maximum Power Dissipation		$P_D$	250	W	
Isolation Voltage	@AC 1 minutes	$V_{isol}$	2500	V	
Storage Temperature		$T_{stg}$	-40 ~ 125	°C	
Mounting Torque(M6)		-	4.0	N.m	
Terminal Torque(M5)	Typical Including Screws	-	2.0	N.m	
Weight		-	120	g	

**Electrical Characteristics @T<sub>c</sub> = 25°C(unless otherwise specified)**

Characteristics	Conditions	Symbol	Min.	Typ.	Max.	Unit	
Cathode Anode Breakdown Voltage	I <sub>R</sub> =100uA	V <sub>R</sub>	1200	-	-	V	
Diode Maximum Forward Voltage	I <sub>F</sub> =75A	V <sub>FM</sub>	T <sub>C</sub> =25°C	-	2.2	2.8	V
			T <sub>C</sub> =100°C	-	2.0	-	
Diode Peak Reverse Recovery Current	T <sub>C</sub> =100°C, V <sub>RRM</sub> applied	I <sub>RRM</sub>	-	-	1.0	mA	
Diode Reverse Recovery Time	I <sub>F</sub> =1A, V <sub>R</sub> =30V di/dt = -150A/uS	t <sub>rr</sub>	-	30	45	ns	
Diode Reverse Recovery Time	I <sub>F</sub> =75A, V <sub>R</sub> =600V di/dt = -150A/uS	t <sub>rr</sub>	T <sub>C</sub> =25°C	-	110	-	ns
			T <sub>C</sub> =100°C	-	180	-	

**Thermal Characteristics**

Characteristics	Conditions	Symbol	Min.	Typ.	Max.	Unit
Thermal Resistance(Isolation Type)	Junction to Case	R <sub>th(j-c)</sub>	-	-	0.5	°C/W

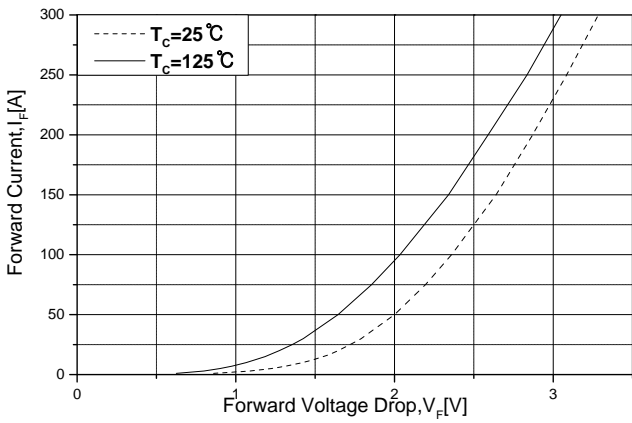

**Fig.1 Typical Forward Voltage Drop vs. Instantaneous Forward Current**

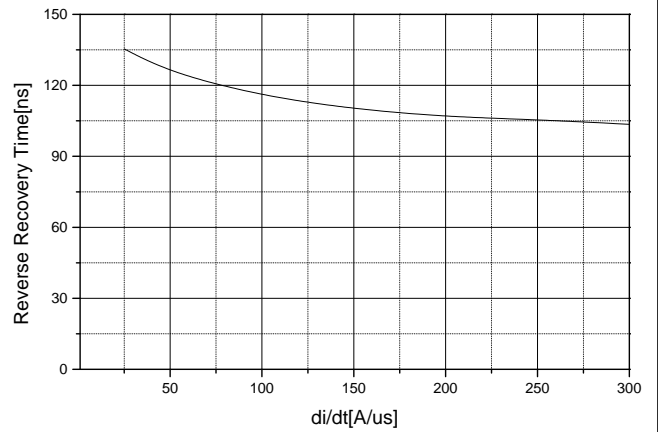

**Fig.2 Typical Reverse Recovery Time Vs.  $-di/dt$**

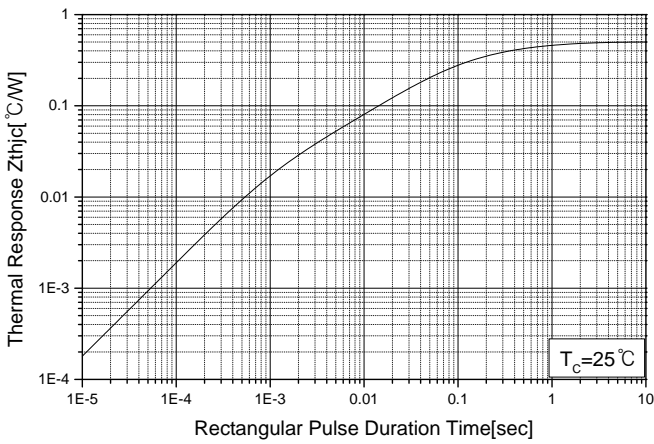

**Fig.3 Transient Thermal Impedance ( $Z_{thjc}$ ) Characteristics**

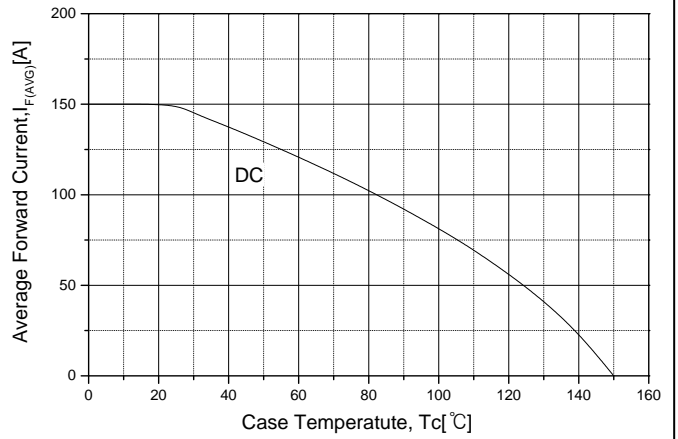
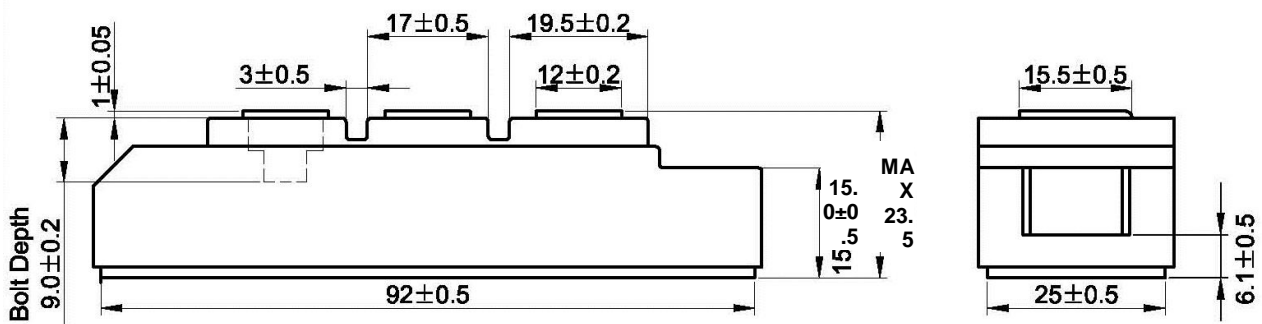
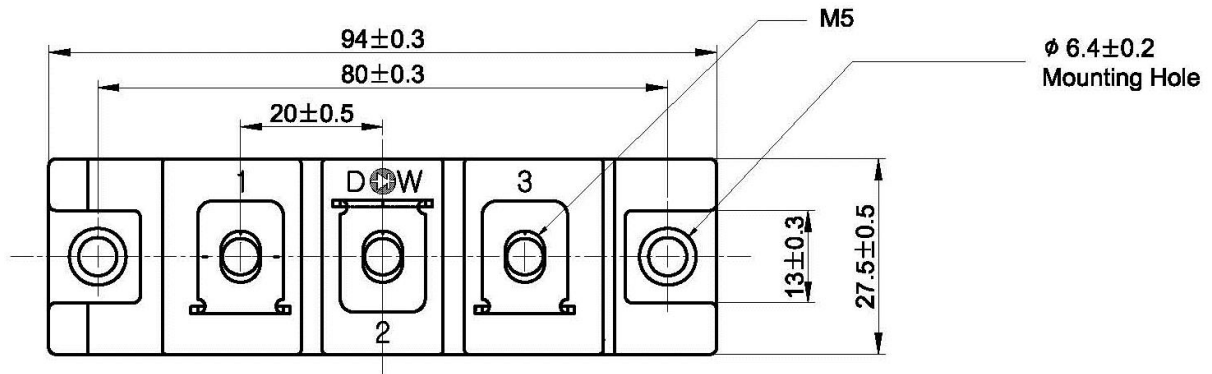

**Fig.4 Forward Current Derating Curve**

Package Dimension

5DM-1

Dimensions are in millimeters, unless otherwise specified



**DISCLAIMER:**

The Products are not designed for use in hostile environments, including, without limitation, aircraft, nuclear power generation, medical appliances, and devices or systems in which malfunction of any Product can reasonably be expected to result in a personal injury. Seller's customers using or selling Seller's products for use in such applications do so at their own risk and agree to fully defend and indemnify Seller.

MagnaChip reserves the right to change the specifications and circuitry without notice at any time. MagnaChip does not consider responsibility for use of any circuitry other than circuitry entirely included in a MagnaChip product. [MagnaChip](#) is a registered trademark of MagnaChip Semiconductor Ltd.