



# AMDV040N036LVRH

Automotive MOSFET 40V 3.6mΩ 80A

## FEATURES

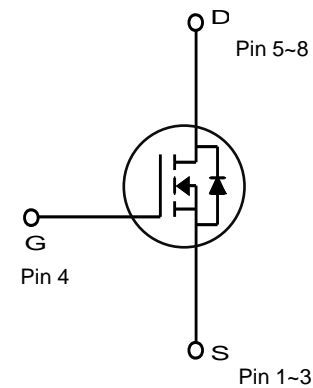
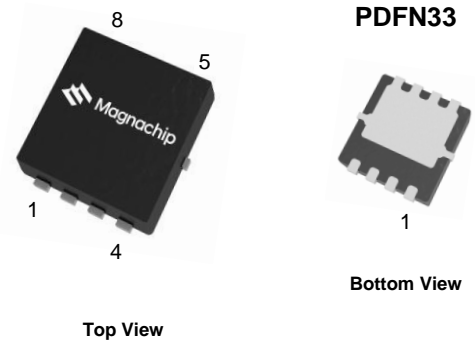
- Trench power MOSFET technology
- Single N-channel trench, Logic level
- Enhanced avalanche ruggedness
- 100% Avalanche tested
- Maximum 175°C junction temperature
- AEC-Q101 qualified and PPAP capable

## APPLICATIONS

- Switching applications
- Motor drive systems

## KEY PERFORMANCE PARAMETERS

$V_{DS}$	40	V
$R_{DS(on), typ.}$	0.0027	$\Omega$
$I_D$	80	A
$Q_G$	27	nC
Junction temperature <sub>, max</sub>	175	°C



## ORDERING INFORMATION

Type / Ordering Code	Package	Marking	Packing	RoHS Status
AMDV040N036LVRH	PDFN33	040N036L	Tape & Reel	Halogen Free

<http://www.magnachip.com/>

**ABSOLUTE MAXIMUM RATINGS**, at  $T_c = 25^\circ\text{C}$ , unless otherwise specified

PARAMETER		SYMBOL	RATING	UNIT
Drain-source Voltage		$V_{DS}$	40	V
Gate-source Voltage		$V_{GS}$	$\pm 20$	
Drain current	$T_c=25^\circ\text{C}$ (Silicon Limited)	$I_D$	96	A
	$T_c=25^\circ\text{C}$ (Package Limited)		80	
	$T_c=100^\circ\text{C}$		68	
<sup>1)</sup> Pulsed drain current	$T_c=25^\circ\text{C}$	$I_{DM}$	320	
Total power dissipation	$T_c=25^\circ\text{C}$	$P_{tot}$	60	W
	$T_c=100^\circ\text{C}$		30	
<sup>2)</sup> Avalanche energy, single pulse		$E_{AS}$	61	mJ
Operating and storage temperature		$T_j, T_{stg}$	- 55 ~ 175	$^\circ\text{C}$

**THERMAL CHARACTERISTICS**

PARAMETER		SYMBOL	RATING	UNIT
Thermal resistance, junction - case		$R_{\theta JC}$	2.5	K/W
<sup>3)</sup> Thermal resistance, junction - ambient		$R_{\theta JA}$	60	

ELECTRICAL CHARACTERISTICS (T<sub>J</sub> = 25°C)

## STATIC CHARACTERISTICS

PARAMETER	Symbol	Min.	Typ.	Max.	Unit	Conditions / Note
Drain-source breakdown voltage	V <sub>(BR)DSS</sub>	40	-	-	V	V <sub>GS</sub> =0 V, I <sub>D</sub> =250 μA
Gate threshold voltage	V <sub>GS(th)</sub>	1.1	-	2.5	V	V <sub>DS</sub> =V <sub>GS</sub> , I <sub>D</sub> =250 μA
Zero gate voltage drain current	I <sub>DSS</sub>	-	-	1	μA	V <sub>DS</sub> =40 V, V <sub>GS</sub> =0 V
Gate-source leakage current	I <sub>GSS</sub>	-	-	± 100	nA	V <sub>GS</sub> =±20 V, V <sub>DS</sub> =0 V
Drain-source on-state resistance	R <sub>DS(on)</sub>	-	4.2	6.0	mΩ	V <sub>GS</sub> =4.5 V, I <sub>D</sub> =20 A
		-	2.7	3.6		V <sub>GS</sub> =10V, I <sub>D</sub> =20 A
<sup>4)</sup> Gate resistance	R <sub>G</sub>	-	3.0	-	Ω	f=1 MHz
<sup>4)</sup> Transconductance	g <sub>fs</sub>	-	85	-	S	V <sub>DS</sub> =10 V, I <sub>D</sub> =40 A

<sup>4)</sup> DYNAMIC CHARACTERISTICS

PARAMETER	Symbol	Min.	Typ.	Max.	Unit	Conditions / Note
Input capacitance	C <sub>iss</sub>	-	1710	-	pF	V <sub>GS</sub> =0 V, V <sub>DS</sub> =20 V, f=1 MHz
Output capacitance	C <sub>oss</sub>	-	500	-		
Reverse transfer capacitance	C <sub>rss</sub>	-	45	-		
Turn-on delay time	t <sub>d(on)</sub>	-	12	-	ns	V <sub>DD</sub> =20 V, V <sub>GS</sub> =10 V, I <sub>D</sub> =40 A, R <sub>G,ext</sub> =3 Ω
Rise time	t <sub>r</sub>	-	7	-		
Turn-off delay time	t <sub>d(off)</sub>	-	37	-		
Fall time	t <sub>f</sub>	-	11	-		

<sup>4)</sup> GATE CHARGE CHARACTERISTICS

PARAMETER	Symbol	Min.	Typ.	Max.	Unit	Conditions / Note
Gate to source charge	Q <sub>gs</sub>	-	5	-	nC	V <sub>DD</sub> =32 V, I <sub>D</sub> =40 A, V <sub>GS</sub> =0 to 10 V
Gate charge at threshold	Q <sub>gs(th)</sub>	-	3	-		
Gate to drain charge	Q <sub>gd</sub>	-	6	-		
Switching charge	Q <sub>sw</sub>	-	8	-		
Gate charge total	Q <sub>g</sub>	-	27	-		
Gate plateau voltage	V <sub>plateau</sub>	-	3.4	-	V	

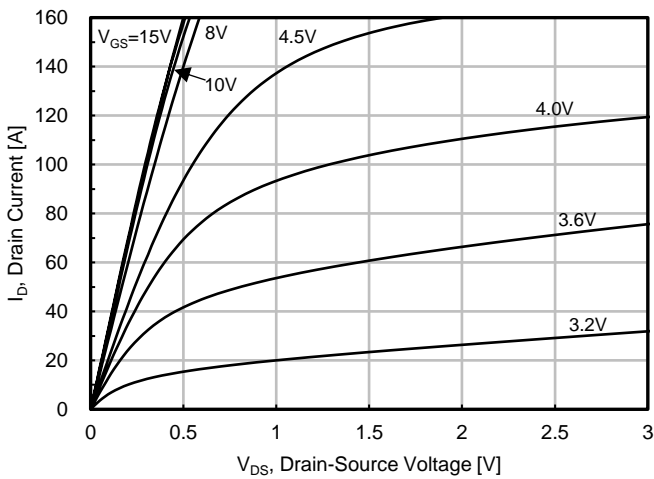
## SOURCE-DRAIN DIODE

PARAMETER	Symbol	Min.	Typ.	Max.	Unit	Conditions / Note
<sup>4)</sup> Diode continuous forward current	I <sub>S</sub>	-	-	80	A	-
<sup>4)</sup> Diode pulse current	I <sub>S,pulse</sub>	-	-	320		pulsed; t <sub>p</sub> ≤ 10 μs
Diode forward voltage	V <sub>SD</sub>	-	0.8	1.1	V	V <sub>GS</sub> =0 V, I <sub>F</sub> =20 A
<sup>4)</sup> Reverse recovery time	t <sub>rr</sub>	-	42	-	ns	I <sub>F</sub> =40 A, d <sub>iF</sub> /dt=100 A/μs
<sup>4)</sup> Reverse recovery charge	Q <sub>rr</sub>	-	38	-	nC	

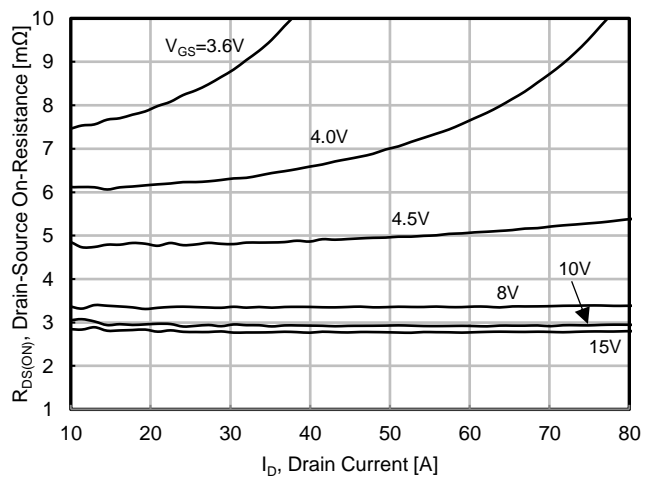
## Notes

- Pulse width limited by T<sub>Jmax</sub>
- Starting T<sub>J</sub>=25°C, L=1mH, I<sub>AS</sub>=11A, V<sub>DD</sub>=36V, V<sub>GS</sub>=10V
- Surface mounted FR-4 board by JEDEC (jesd51-7)
- The parameter is not subject to production testing - guaranteed by design.

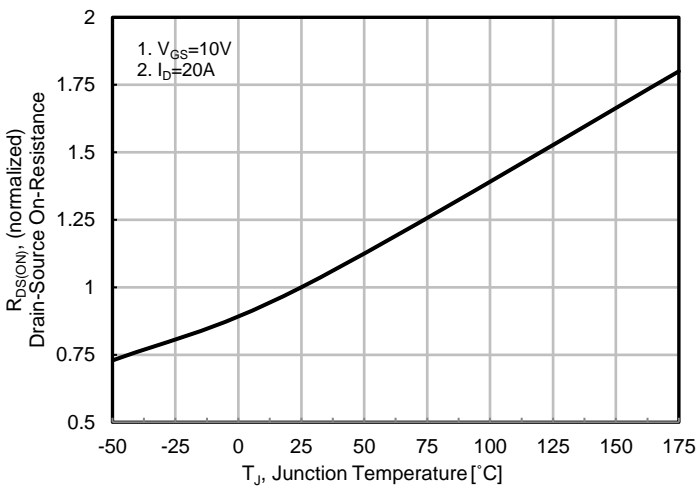
**ELECTRICAL CHARACTERISTICS DIAGRAMS (25 °C, unless otherwise noted)**



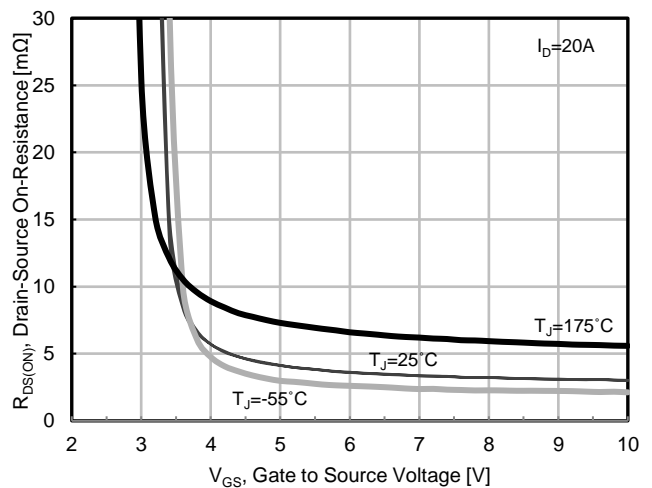
**Fig. 1. Typ. Output Characteristics**



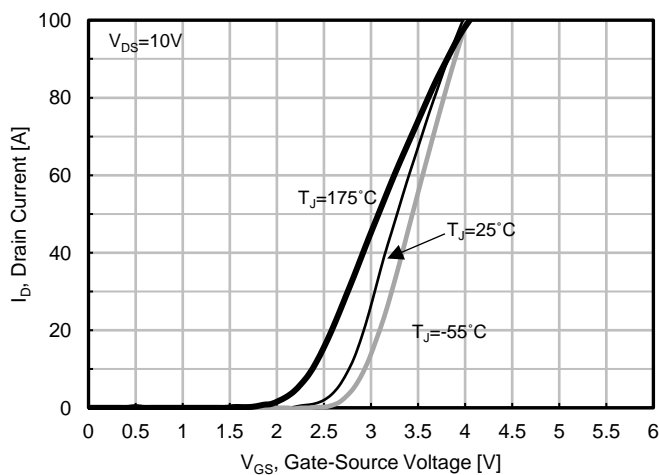
**Fig. 2. Typ. Drain to Source On-Resistance**



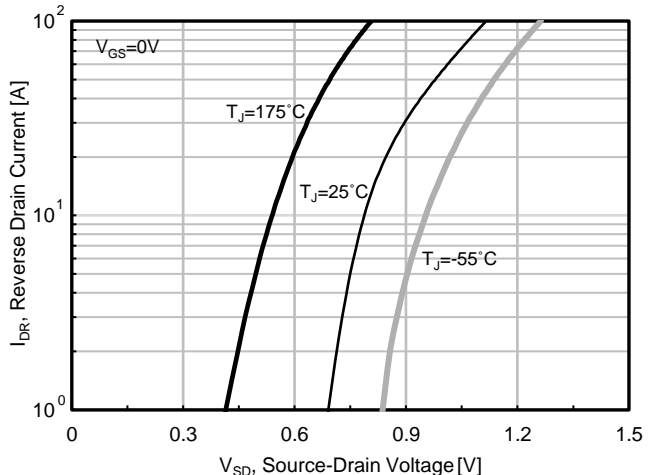
**Fig. 3. On-Resistance vs. Junction Temperature**



**Fig. 4. On-Resistance vs. Gate to source Voltage**

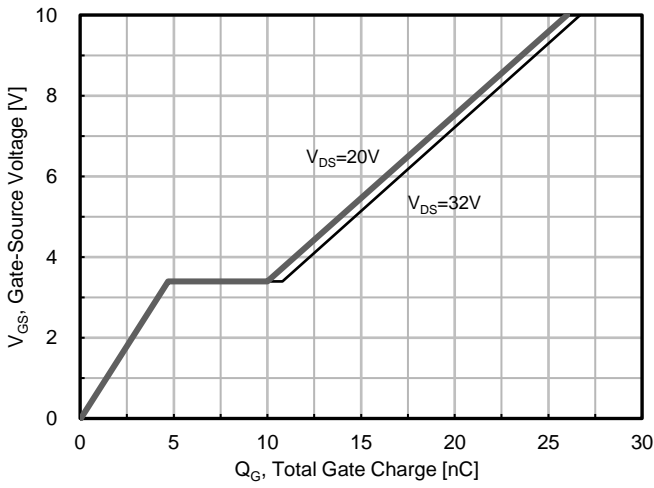


**Fig. 5. Typ. Transfer Characteristics**

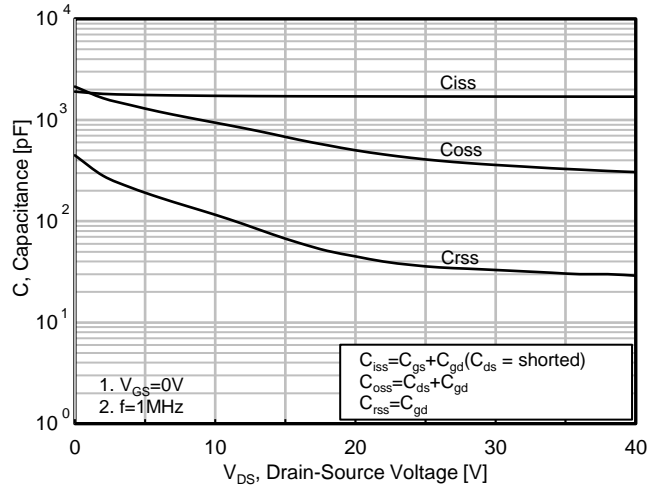


**Fig. 6. Forward Characteristics of Reverse Diode**

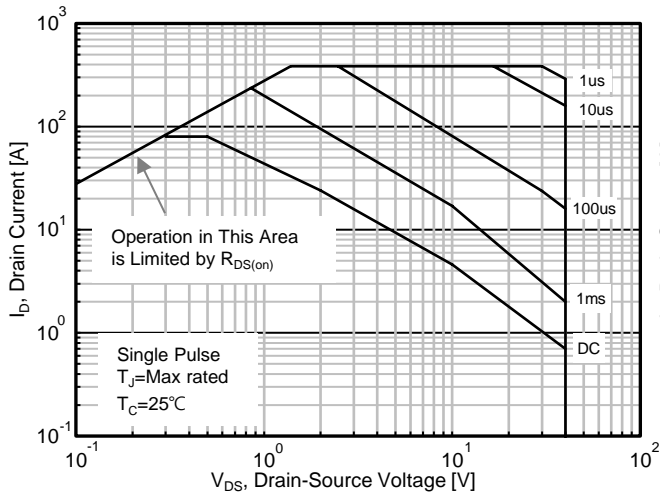
**ELECTRICAL CHARACTERISTICS DIAGRAMS (25 °C, unless otherwise noted)**



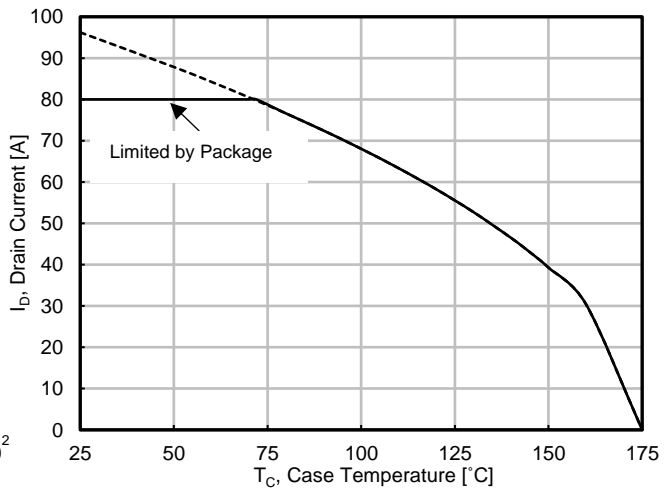
**Fig. 7. Typ. Gate Charge**



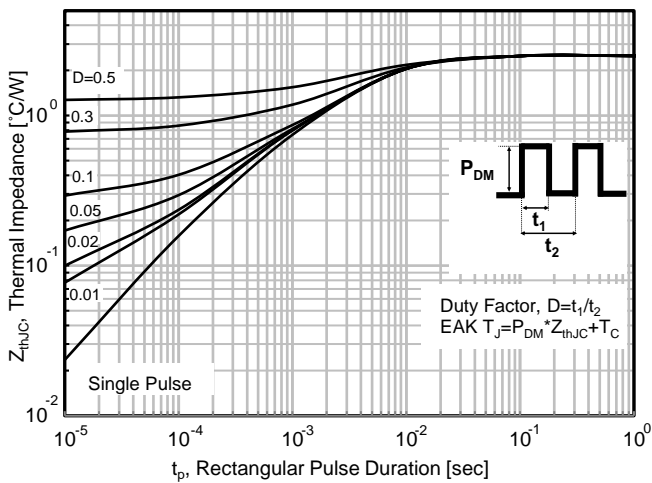
**Fig. 8. Typ. Capacitance**



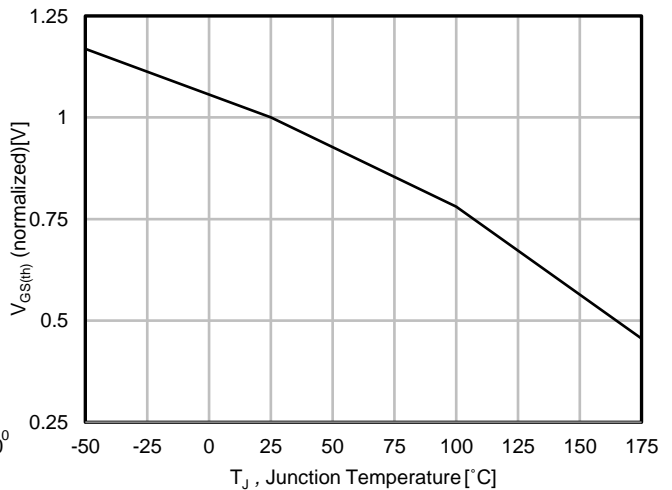
**Fig. 9. Safe Operating Area**



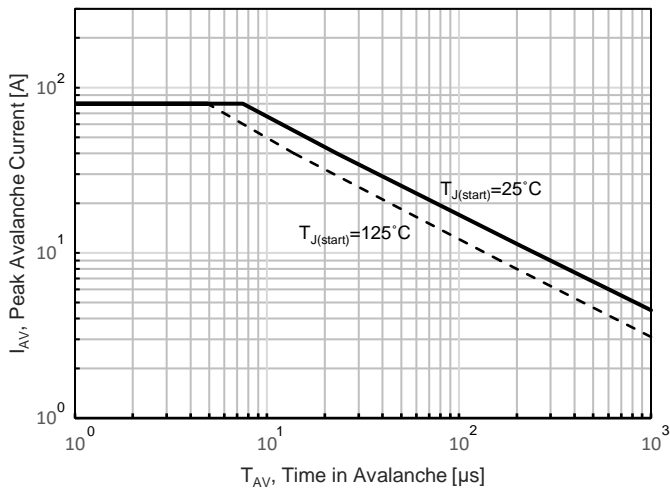
**Fig. 10. Drain Current vs. Temperature**



**Fig. 11. Transient Thermal Impedance**

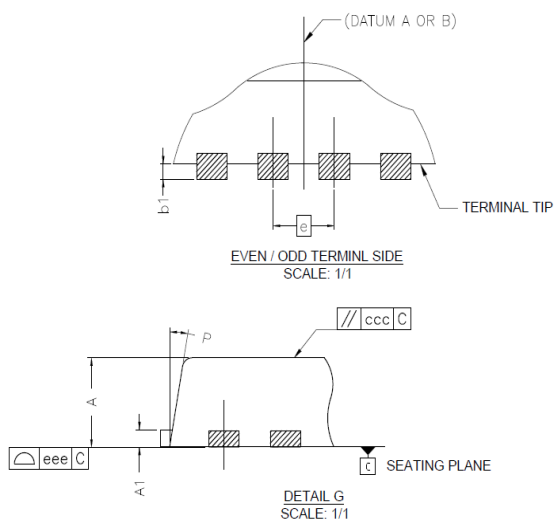
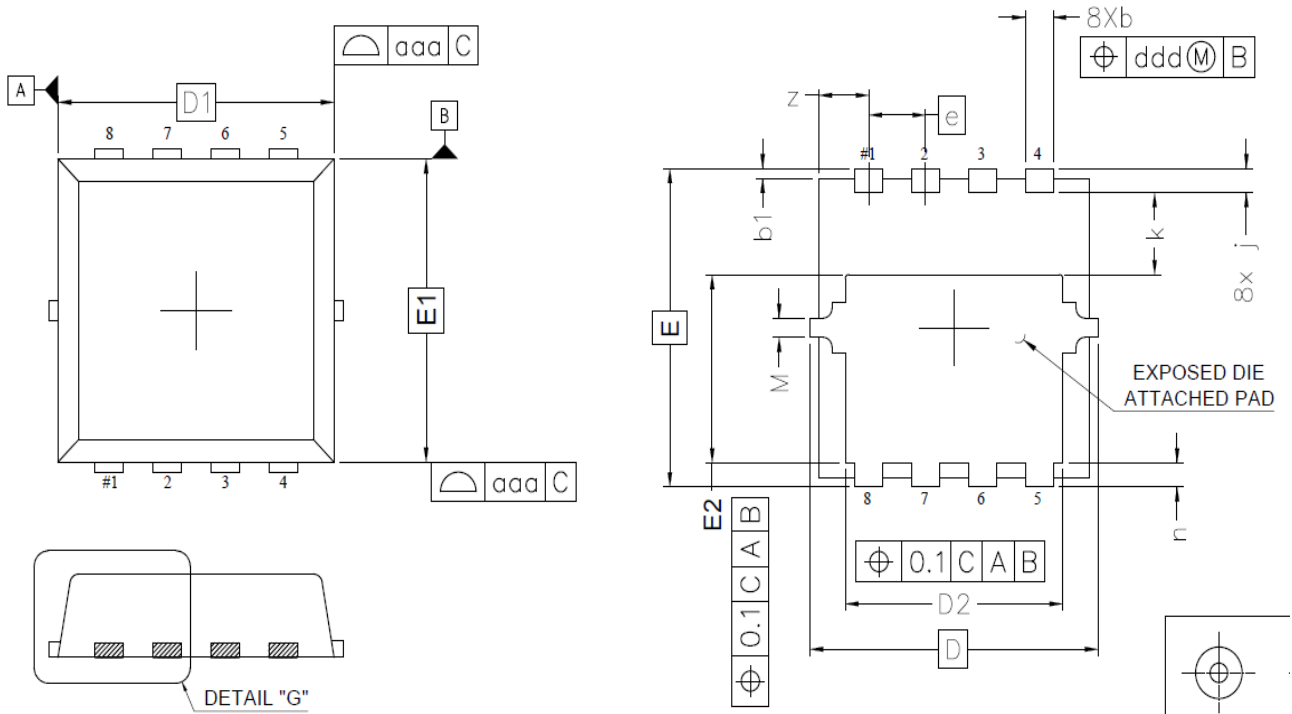


**Fig. 12. VGS(th) Variation with Temperature (Normalized)**

**ELECTRICAL CHARACTERISTICS DIAGRAMS (25 °C, unless otherwise noted)****Fig. 13. Avalanche Characteristics**

# Package Outlines

PDFN33




SYMBOL	MIN	MAX	SYMBOL	MIN	MAX
A	0.80	0.90	M	0.20	
A1	0.12	0.22	P	9°	11°
b	0.22	0.42	z	0.58	
b1	0.05	0.15	aaa	0.10	
D	3.30 BSC		ccc	0.10	
D1	3.10 BSC		ddd	0.05	
D2	2.29	2.69	eee	0.05	
E	3.30 BSC				
E1	3.10 BSC				
E2	1.85	2.05			
e	0.65 BSC				
j	0.15	0.35			
k	0.75	0.95			
n	0.15	0.35			

**Notes**

Package body size, length and width do not include mold flash, protrusions and gate burrs.

**DISCLAIMER :**

The Products are not designed for use in hostile environments, including, without limitation, aircraft, nuclear power generation, medical appliances, and devices or systems in which malfunction of any Product can reasonably be expected to result in a personal injury. Seller's customers using or selling Seller's products for use in such applications do so at their own risk and agree to fully defend and indemnify Seller.

Magnachip reserves the right to change the specifications and circuitry without notice at any time. Magnachip does not consider responsibility for use of any circuitry other than circuitry entirely included in a Magnachip product.  Magnachip is registered trademark of Magnachip Semiconductor Ltd.